



# nbn® New Developments Pit and Pipe Design Guidelines

<b>Document number</b>	NBN-COO-EDS-017
<b>Document category</b>	Guide
<b>Approver (owner)</b>	EGM, Engineering
<b>Status</b>	Approved
<b>Issue date</b>	20 February 2023
<b>Revision number</b>	8



# 1 Disclaimer

This document is provided for information purposes only. This document is subject to the information classification set out on this page. If no information classification has been included, this document must be treated as UNCLASSIFIED, SENSITIVE and must not be disclosed other than with the consent of **nbn** co. The recipient (including third parties) must make and rely on their own inquiries as to the currency; accuracy and completeness of the information contained herein and must not use this document other than with the consent of **nbn** co.

Copyright © 2023 **nbn** co limited. All rights reserved.

# 2 Document control

## Revision history

Date	Revision	Details
28 FEB 23	8.0	Addition of <b>nbn</b> ® Smart Places
04 APR 18	5.5	Updated to include EPR command; Manhole command; Manhole configuration; <b>NBN</b> Reference Number.
9 NOV 16	5.4	Updated to include reference to type 6 pits and Manholes
19 NOV 15	5.3	Updated with Peer Review feedback
18 SEP 15	5.2	Issued updated draft for peer review. Rebranded and refreshed to reflect ADT improvements, bug fixes and incorporate Geo Referencing hints.
15 DEC 14	5.1	Updated with new DCTUPD Command Updated Xdata
07 JUL 14	5.0	Issued
	4.1	Updated with new ADT information; feedback, addressing information; address command; checklists; colour references. New nbn style guidelines applied. General streamlining of headings and content Changed name from NBN-COO-P&D-017 to NBN-COO-EDS-017
28 JAN 14	4.0	Issued
20 JAN 13	3.2	Updated with new ADT information; feedback, addressing information; address command; checklists; colour references. New nbn style guidelines applied. General streamlining of headings and content.
02 SEP 13	3.1	Updated with new ADT tool; feedback, addressing information; address command; checklists; colour references.
13 APR 12	3.0	Issued



12 APR 12	2.2	Changed name from NBN-TE-CTO-586 to NBN-COO-P&D-017
14 FEB 12	2.1	AutoCAD units precision updated; Xdata introduced according to NBN CAD Standards
09 JAN 12	2.0	Issued
30 JUN 11	1.1	ADT added; BOM tool added
	1.0	Issued



# 3 Contents

## Contents

<b>1 Disclaimer</b> .....	<b>2</b>
<b>2 Document control</b> .....	<b>2</b>
<b>3 Contents</b> .....	<b>4</b>
3.1 Figures .....	7
3.2 Tables .....	7
<b>1 About this document</b> .....	<b>9</b>
1.1 Purpose .....	9
1.2 Audience .....	9
1.3 Related documents .....	9
1.4 Attachments .....	9
1.5 Changes in this revision .....	10
<b>2 Introduction</b> .....	<b>11</b>
<b>3 AutoCAD template</b> .....	<b>13</b>
3.1 AutoCAD software requirements .....	13
3.2 Design settings .....	13
3.2.1.1 Layers .....	13
3.2.2 Drawing units .....	14
3.2.3 Blocks .....	15
3.2.4 Scaling .....	16
3.2.5 Base data .....	16
3.2.6 Title block .....	16
3.2.7 Projection .....	17
<b>3.3 Geo-referencing</b> .....	<b>19</b>
3.3.1 Using Google Earth and Google Maps .....	19
3.3.2 Using Google Earth only .....	26
3.4 XData (extended entity data) .....	27



<b>4</b>	<b>Assisted drafting tool (ADT)</b> .....	<b>28</b>
4.1	Installation instructions.....	28
<b>5</b>	<b>Drafting guidelines</b> .....	<b>29</b>
5.1	Cadastre layer fix .....	29
<b>5.2</b>	<b>Different stages displaying standards</b> .....	<b>31</b>
<b>5.3</b>	<b>Current development stage boundary</b> .....	<b>31</b>
<b>5.4</b>	<b>Development information</b> .....	<b>32</b>
<b>5.5</b>	<b>Addresses</b> .....	<b>33</b>
5.5.1	Assisted drafting tool (Address):.....	35
<b>5.6</b>	<b>Pits &amp; Manholes</b> .....	<b>37</b>
5.6.1	Assisted drafting tool (PIT):.....	38
5.6.2	Assisted drafting tool (Manhole):.....	39
<b>5.7</b>	<b>Conduits</b> .....	<b>40</b>
5.7.1	Assisted drafting tool (conduit):.....	41
5.7.1.1	Multiple conduits .....	42
5.7.1.2	Distinct multiple conduits .....	42
5.7.1.3	Manhole and conduit configuration.....	43
5.7.1.4	Lead-ins .....	43
5.7.2	Assisted drafting tool (Duct Update Command) .....	44
<b>5.8</b>	<b>EPR Zone (earth potential rise zone)</b> .....	<b>46</b>
5.8.1	Assisted drafting tool (EPR).....	46
<b>5.9</b>	<b>Shared Trench Symbol</b> .....	<b>47</b>
5.9.1	Assisted drafting tool (STR).....	47
<b>5.10</b>	<b>FDH cabinet</b> .....	<b>48</b>
5.10.1	Assisted drafting tool (FDH): .....	48
<b>5.11</b>	<b>Telstra PIT</b> .....	<b>48</b>
5.11.1	Assisted drafting tool (TPT):.....	49
<b>5.12</b>	<b>Smart Places Non-Premises Locations (NPL)</b> .....	<b>49</b>
<b>5.13</b>	<b>Bill of Materials</b> .....	<b>54</b>
5.13.1	Assisted Drafting Tool (BOM): .....	56



<b>5.14</b>	<b>Quality audit for pit and pipe design.....</b>	<b>57</b>
5.14.1	Assisted drafting tool (QA):.....	58
<b>6</b>	<b>Contact us .....</b>	<b>59</b>
6.1	Design submission and queries .....	59
6.2	Assisted drafting tool (ADT) support .....	59
<b>7</b>	<b>Checklists.....</b>	<b>60</b>



## 3.1 Figures

Figure 1. Layers from the PIT&PIPE-NEWDEVELOPMENT filter group.....	14
Figure 2. Map grid of Australia .....	17
Figure 3. Correctly placed drawing.....	18
Figure 4. Corrupt image in KMZ file.....	18
Figure 5. Coordinate System setting .....	19
Figure 6. Bad cadastre layer example .....	30
Figure 7. Good cadastre layer example .....	30
Figure 8. Current development stage boundary .....	32
Figure 9. Example of development information in the drawing .....	33
Figure 10. Example of street name as one MText object.....	34
Figure 11. Conduit.....	40
Figure 12. Matching multiple conduits.....	42
Figure 13. Distinct multiple conduits.....	43
Figure 14. Distinct multiple conduits (Manholes).....	43
Figure 15. (BOM) reflects the edit made.....	46
Figure 16. Example of BOM in the drawing.....	56

## 3.2 Tables

Table 1. AutoCAD drawing unit set-up.....	14
Table 2. AutoCAD font style set-up.....	15
Table 3. Required blocks.....	15
Table 4. Title block and view ports.....	17
Table 5. Colour formatting.....	31
Table 6. Development attributes.....	32
Table 7. Address block attributes.....	34
Table 8. Pit types .....	37
Table 9. NBN PIT- block attributes .....	37
Table 10. Parts of conduit drawing .....	41



<u>Table 11. XData attributes for DUCT .....</u>	<u>41</u>
<u>Table 12. NBN CAP block attributes .....</u>	<u>43</u>
<u>Table 13. NBN FDH block attributes .....</u>	<u>48</u>
<u>Table 14. NBN TPT block attribute.....</u>	<u>49</u>
<u>Table 15 – NPL PIT Command.....</u>	<u>50</u>
<u>Table 16 – NPL Building Type Instructions .....</u>	<u>51</u>
<u>Table 17 For a Standard Premise .....</u>	<u>54</u>
<u>Table 18. BOM block attributes .....</u>	<u>54</u>
<u>Table 19. QA command.....</u>	<u>57</u>
<u>Table 20. NBN FIX text description .....</u>	<u>58</u>





# 1 About this document

## 1.1 Purpose

The purpose of this document is to provide Developers with key Assisted Drafting Tool (ADT) information, **nbn** CAD standards and database compatibility requirements to be followed when creating pit and pipe designs. Developers should also follow all requirements of their developer agreement or other agreement with **nbn**.

## 1.2 Audience

This document is intended for New Estate Developers and their design contractors.

## 1.3 Related documents

Document	Owner and link
NBN-TE-CTO-194	New Developments: Deployment of the NBN Conduit & Pit Network – Guidelines for Developers

## 1.4 Attachments

Document No.	Filename	Link
NBN-COO-EDS-017, Attachment 1	Pre Construct Handover Checklist for New Development P&P Design	<a href="https://nbnco.com.au/pre-construct-handover-checklist">Pre-construct handover checklist   nbn (nbnco.com.au)</a>
NBN-COO-EDS-017, Attachment 2	As Built Handover Checklist for New Development P&P Design	<a href="https://nbnco.com.au/as-built-handover-checklist">As-built handover checklist   nbn (nbnco.com.au)</a>



## 1.5 Changes in this revision

Changes in this document revision 8.0 dated <28-02-2023> compared to the previous revision 7.0 is summarised below:

Section	Details
5.5.1	Update Commands to ADT (Addresses)
5.6.1	Updated Table 4
NEW – 5.12	Smart Places Non-Premise Locations (NPL)
5.14.1	Updated table 20
7	Updated links to relevant checklists

Revision 7

Section	Details
1.5 - Changes in this revision:	– Revision document number Updated.
All sections	More uniform instructions and improved wording for clarity.
2 - Introduction:	Updated section 1c – New Development template updated 2017.dwt



## 2 Introduction

The aim of this document is to provide Developers with:

- Key **nbn** drafting requirements.
- A description of the ADT and AutoCAD Template to be used when creating and submitting New Development Pit and Pipe Designs for comment by **nbn** in accordance with the applicable developer agreement

### Developer agreement requirements

This document does not affect Developer's obligations under their Developer Agreement or other agreement with **nbn**.

For example, while under the Developer Agreement, the Developer must submit the design for comment by **nbn** and the design remains the responsibility of the Developer, regardless of any review or commenting by **nbn** on the design.

As part of its agreement with **nbn**, the Developer warrants that the design for each stage will:

- a. Comply with all **nbn** specifications as required by the developer agreement.
- b. Be fit for the purpose of constructing the Works and installing and housing the Network Infrastructure in that stage, including as reasonably ascertainable from - **nbn's** specifications.

**nbn** may make comments on, or have additional requirements for, your design even after you submit it and you need to take those comments into account (whether covered in this document or otherwise) to modify your design accordingly and resubmit it to **nbn**.

The Developer must not commence building until **nbn** has confirmed it has no additional comments on the design, or **nbn** has not provided any comments on the design within 20 business days of it being submitted (or if submitted before the developer agreement is signed, 20 business days from the developer agreement being signed).

Resources available on the **nbn** website:

1. [Upload designs | nbn \(nbnco.com.au\)](https://nbnco.com.au) **ZIP file**

The zip file contains:

- a. ADT (assisted drafting tool) file ADT.VLX
- b. Documents
  - EDS017 – **nbn** New Development Pit and Pipe Design Guidelines (this document)
  - EDS017 – Att 1 – Pre-Construct Handover Checklist
  - EDS017 – Att 2 – As-Built Handover Checklist



c. Templates

- SAMPLE.dwf (can be viewed with 'Autodesk Design Review', a free download software)New\_Development\_template\_2017 .dwt (AutoCAD template)

## 2. Tutorial

Help and guidance on using the ADT is available on the **nbn** website to provide assistance with key **nbn** drafting requirements, the Assisted Drafting Tool (ADT) and the AutoCAD Template which are all required to create and submit acceptable New Development Pit and Pipe Designs.

The format of the tutorial may typically be an online video, slide presentation or similar.



## 3 AutoCAD template

### 3.1 AutoCAD software requirements

External plant drafting will be done using industry standard AutoCAD software and the fundamental 'Model Space' and 'Paper Space' CAD drafting approach.

It is assumed that users undertaking CAD drafting for **nbn** are conversant with use of 'Model Space' and 'Paper Space' in an AutoCAD environment.

The current minimum version of AutoCAD is AutoCAD 2013-R18.

**Note:** all submissions need to be in **.DWG format** and saved in minimum **version 2013 only**.

### 3.2 Design settings

The AutoCAD Template includes symbols, blocks, layers and title blocks. They are explained in detail in this document and intended to assist Developers in adhering to **nbn's** CAD standards.

The sections below outline the drawing setup required.

#### 3.2.1.1 Layers

There are many layers included within the template.

The names are specific to **nbn** systems and are to be used as presented, to load data into **nbn's** database.

To assist with the design of pit and pipe, a filter group called **PIT&PIPE-NEWDEVELOPMENT** is created and all layers required are added to the filter group.

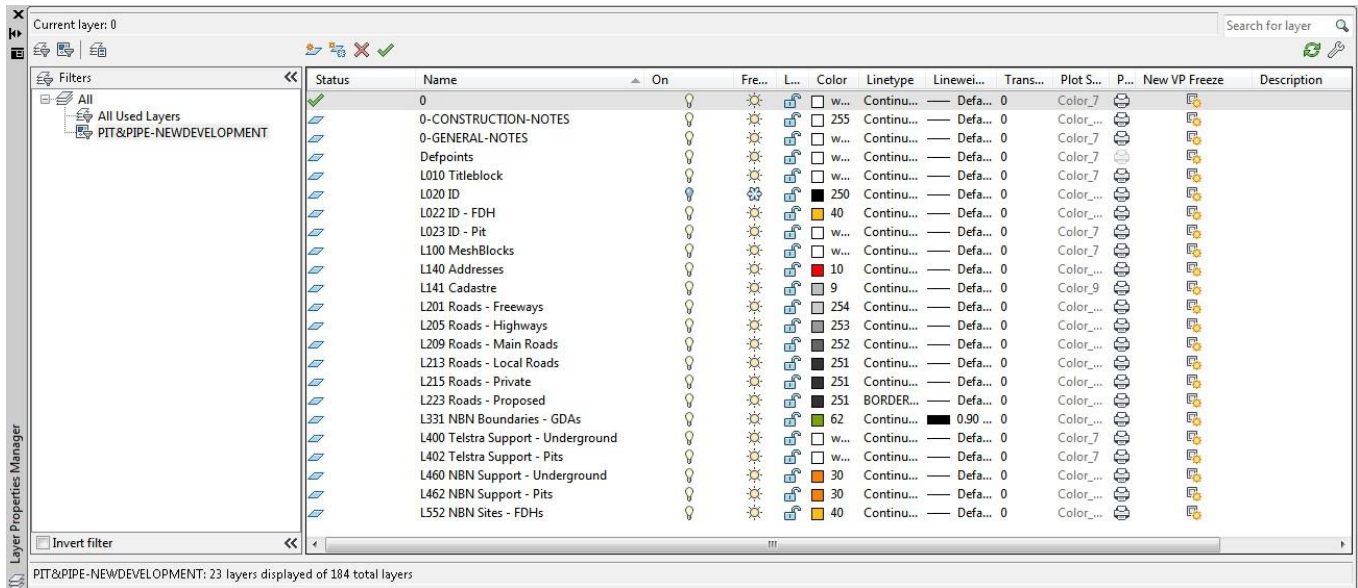

Figure 1. Layers from the PIT&PIPE-NEWDEVELOPMENT filter group

**Note:** Developers can add their own layers to this list, but the pit and pipe network needs to be captured on the specified layers.

### 3.2.2 Drawing units

Drawing units must be set up as per the table below:

Table 1. AutoCAD drawing unit set-up

Drawing Units	Field	Value
Length	Type	Decimal
	Precision	0.00
Angle	Type	Decimal Degrees
	Precision	0.00
	Clockwise	Unticked
Insertion scale	Units to scale inserted content	Unitless
Direction Control - Base Angle	East	0

## Font style

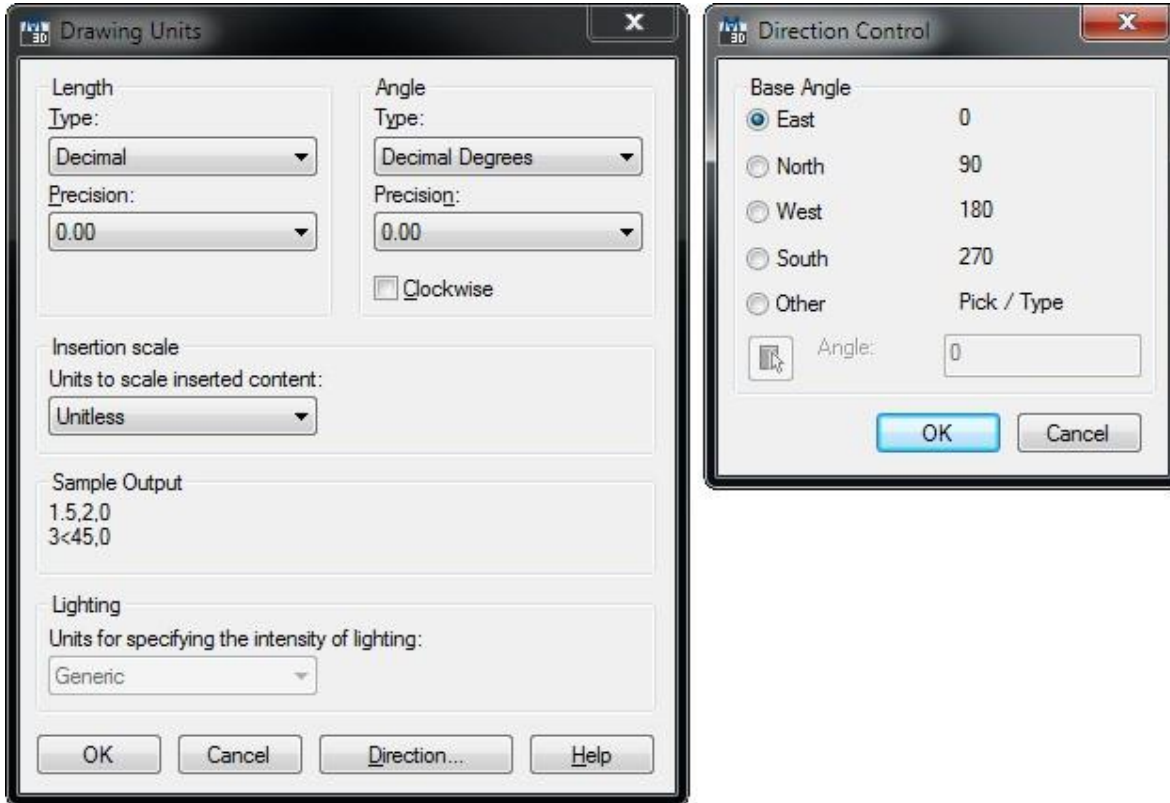

Font style must be adjusted as per the table below:

**Table 2. AutoCAD font style set-up**

Unit	Value
Style in use	Standard
Font Style	Regular
Width Factor	0.8
Font name	ISOCPEUR
Height	2.0
Oblique Angle	0.0

## 3.2.3 Blocks

The table below shows the blocks from the template that must be present in your drawing for the ADT to function properly.

**Table 3. Required blocks**



Block	Description
NBN_PIT	nbn Pit
NBN_TRENCH_ANNO_TYPE	Duct Type Annotation (P100, P50, etc)
NBN_TRENCH_ANNO_LEN	Duct Length Annotation (in metres)
NBN_A1	Title Block
NBN_CAP	End Cap
NBN_TPT	Telstra Pit
NBN_FDHD	FDH Cabinet
NBN_BOM_2017	- Bill of Material
NBN_FIX	QA Issue Tracker (a tag which the QA command attaches to a wrongly designed Pit or Duct).
NBN_NDI	Development Information
NBN_ADDRESS_SDU	Lot Number

### 3.2.4 Scaling

Despite the fact that scale is set to **UNITLESS**, you must draw property boundary lines on a 1:1 scale using **METRES**. This ensures that segments of network are drawn accurately using the nominated blocks.

### 3.2.5 Base data

Property survey data should be brought into the **L141 Cadastre** layer of the drawing. Street names must be placed in **L140 Addresses** layer.

Street numbers inside the development boundary are to be created with the **ADD** command and also placed in the **L140 Addresses** layer.

Any other base data can be presented in the layers not designated for exclusive use by the ADT commands. The designated layers are mentioned later in this document.

### 3.2.6 Title block

When preparing a drawing, the **Title Block** and **View Ports** must be placed on the correct layer, as per the table below:





**Table 4. Title block and view ports**

Item	Layer
Title Block	L010 Titleblock
View Ports	DefPoints

### 3.2.7 Projection

All designs must be geographically oriented to the GDA 94 datum with the correct MGA projection for the area of the country you are working in. The country is divided into 8 zones for each 6 degrees of longitude.

For example, all towns East of Longitude 150 use MGA Zone 56 (GDA94).

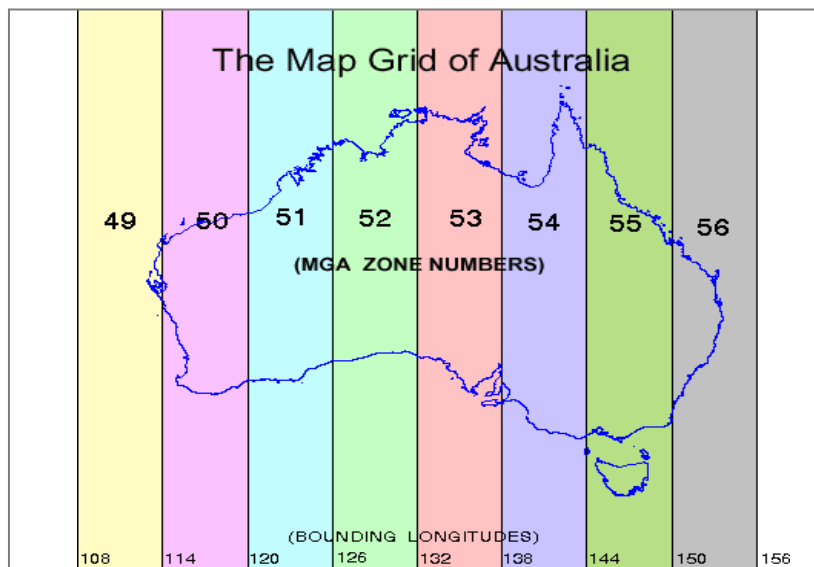

**Figure 2. Map grid of Australia**

Use the above map as a guide to determine the correct MGA Zone for the file you are preparing.

More information can be found at: <http://www.icsm.gov.au/datum/geocentric-datum-australia-1994-gda94>.

**All surveyed data must have the correct geographical location (i.e. it must be ‘geo-referenced’) in order for your design to be commented on by nbn.**

**Important Note:** The first item checked on designs submitted to **nbn** is the MGA zone. If designs are submitted with **incorrect Projection** and/or **incorrect MGA Zone Easting’s and Northings** -, **nbn** will request you correct and resubmit the design.

Your drawing will be tested at **nbn** by producing a Google Earth KMZ file version of the cadastre layer. A drawing correctly referenced to its MGA zone will look correctly placed on the surface of the Globe.



**Figure 3. Correctly placed drawing**

If you have failed to reference your drawing correctly, the KMZ image will look corrupt:

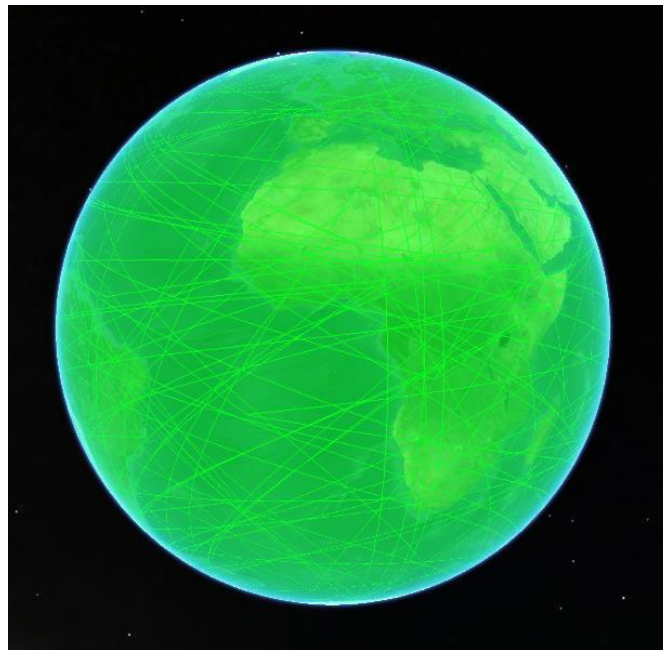

**Figure 4. Corrupt image in KMZ file**

Incorrectly geo-referenced drawings will be rejected and a similar image screenshot sent back to you. In these cases you must go back to your surveyor and request them to provide you with the correct cadastre (property) layer. If that option is not available, you can geo-reference your current design yourself in most cases. Please refer to the section below for details on how to do this.

## 3.3 Geo-referencing

Google Earth, sometimes in combination with Google Maps, can be a good choice for solving geo-referencing problems with a completed, but misplaced - against Australian landmass - drawing.

Geo-referencing is about finding at least three points visible in both Google Earth/Google Maps and your drawing and then moving, scaling and rotating your drawing to make its three points (they are called base points) match the points on the ground (Reference points).

Rubber Sheet feature (ADERSHEET command) in AutoCAD Map 3D is very helpful with the latter. The steps below describe geo-referencing without the Rubber Sheet feature.

Please note that just setting your drawing to the correct MGA zone number does not geo-reference the drawing automatically. The actual Easting's and Northings coordinates are important and must be correct. **nbn's** internal drawing QA/Conversion tool will apply those coordinates to the correct zone number. So this setting is for information purposes only.

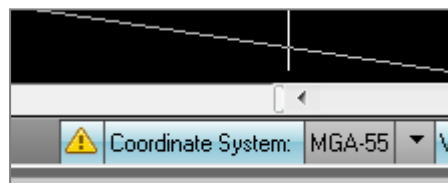

Figure 5. Coordinate System setting

### 3.3.1 Using Google Earth and Google Maps

The steps below describe how to use Google Earth in combination with Google Maps.

**Note:** sometimes lot boundaries only can serve as a visual reference. So you have to pick the true coordinates from the lot boundaries visible in Google Maps.

1. From the **3D View** tab in the *Google Earth Options*, select **Decimal Degrees**.

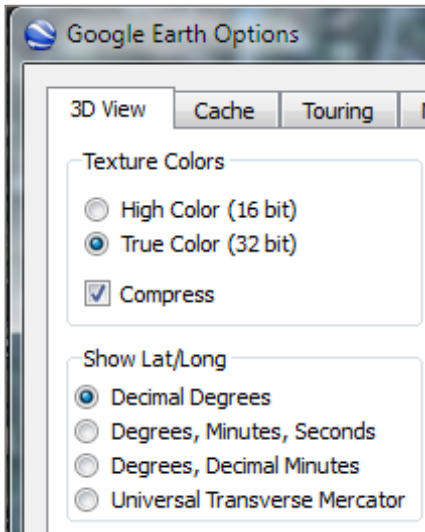

2. Create three place marks in Google Earth, approximately in the corners of the block.
3. Open Google Maps and move to the same location.

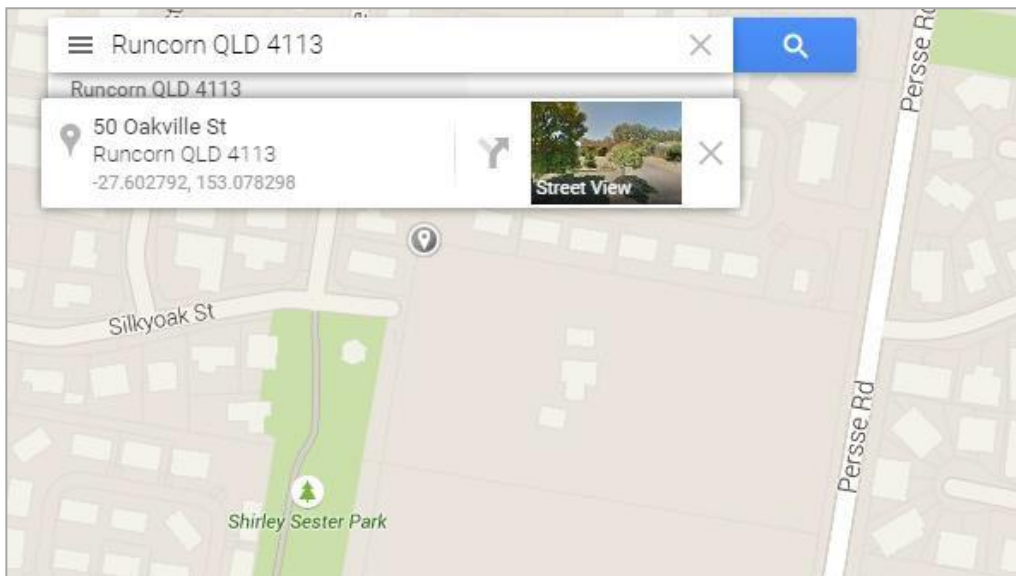

- Rectify each placemark's coordinates by clicking on exactly the block corners you can see in Google Maps and entering the displayed coordinate values into the relevant *Google Earth - Edit placemark* dialog box.

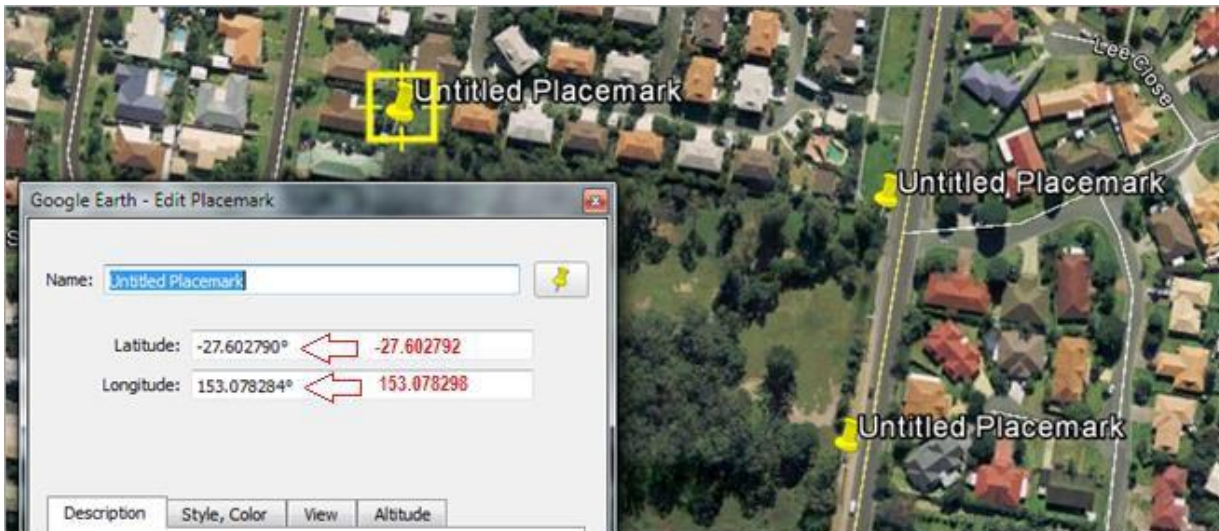

- From the **3D View** tab in the *Google Earth Options*, select **Universal Transverse Mercator (UTM)**.

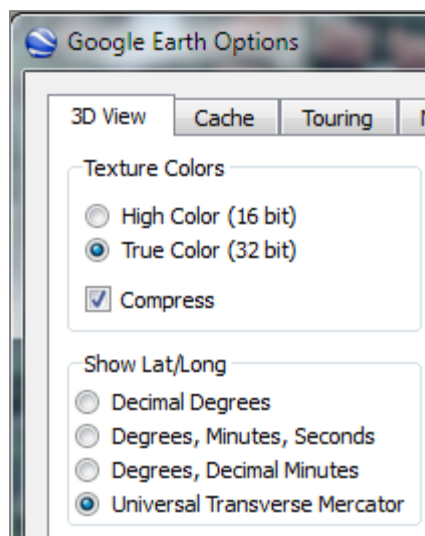

This now gives you the zone and zone coordinates for each placemark.

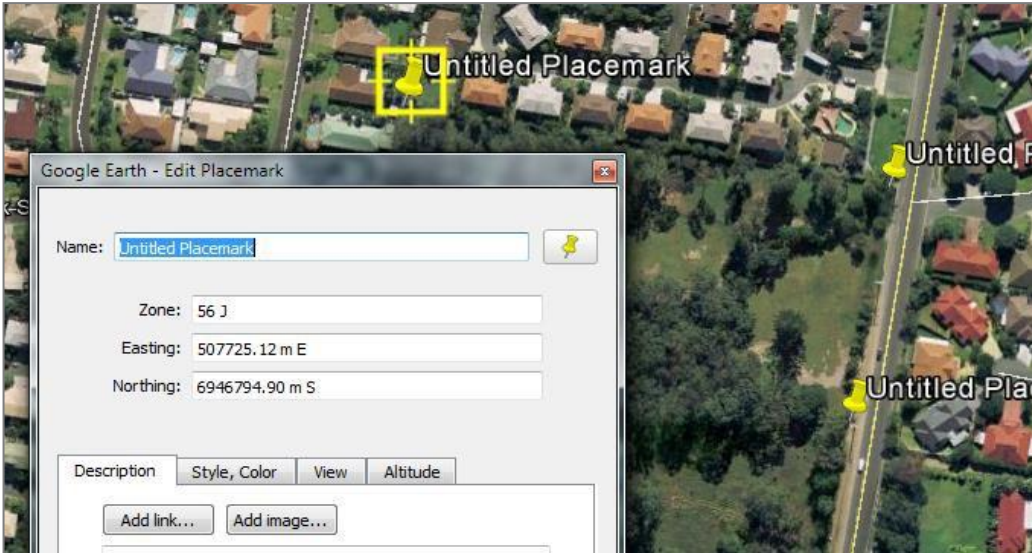

6. Draw lines connecting those UTM point coordinates in your design.
7. Copy the line angle from the properties window.

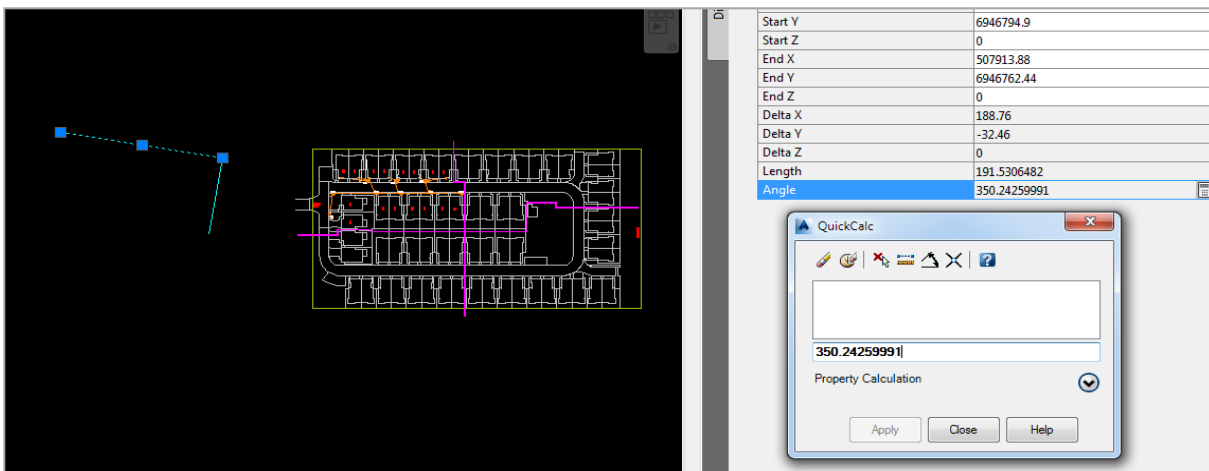

8. Rotate the drawing to match the angle.

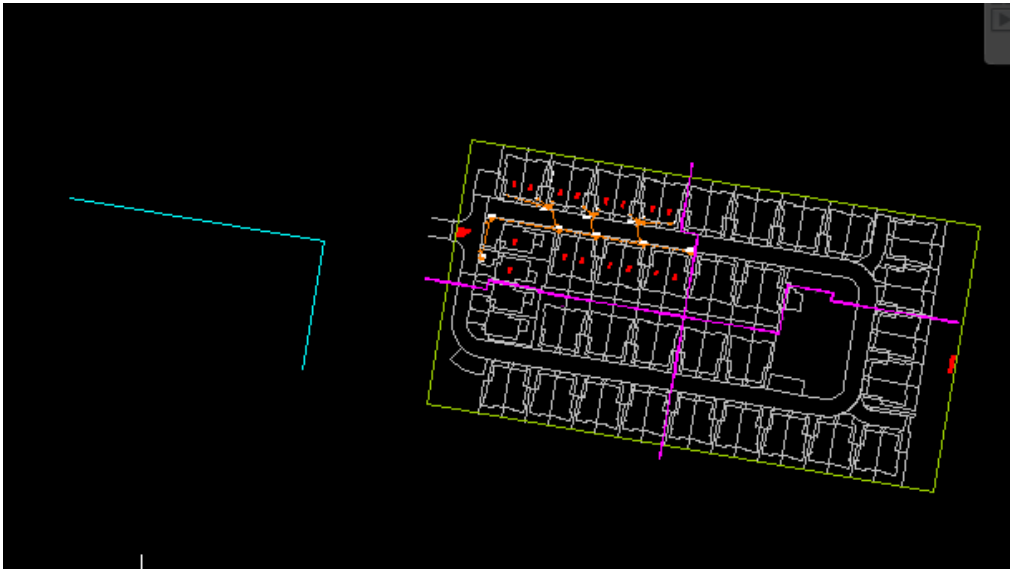

9. Scale the drawing down or up to make it occupy the expected footprint.

**Note:** the scale factor is roughly 0.5 in the example below.

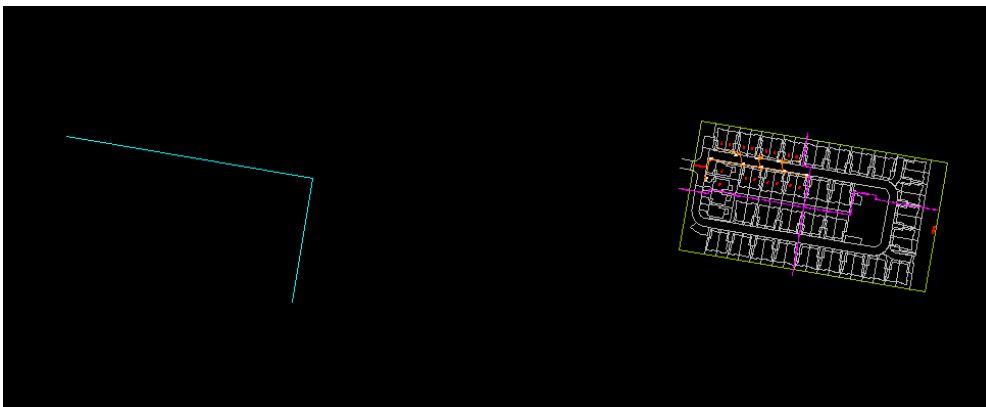

10. Move the drawing into place.

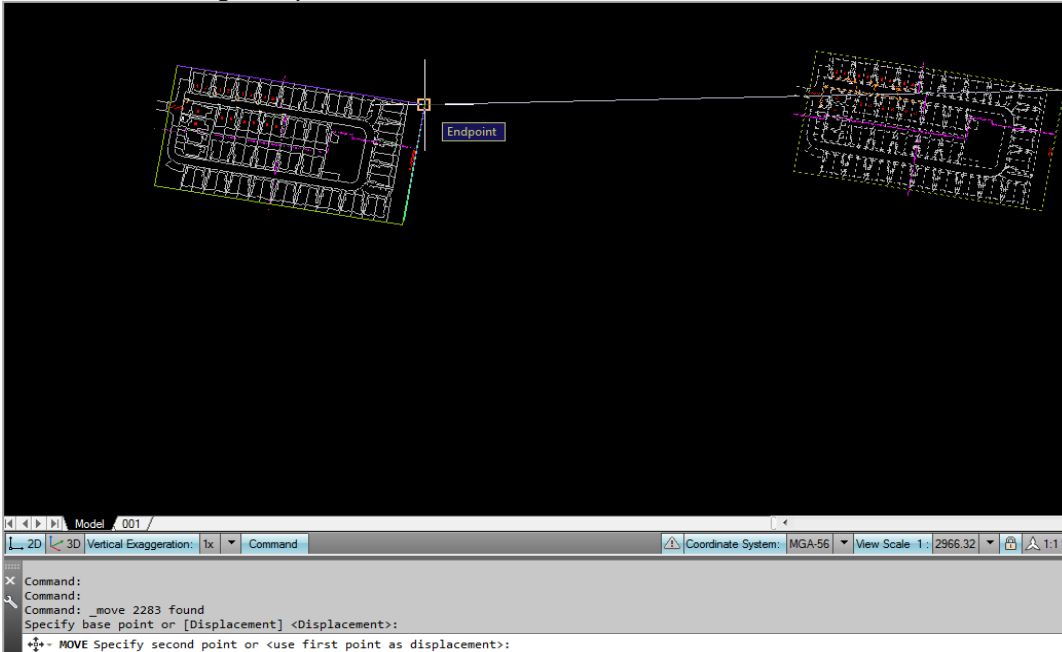

It should now be in the right location.





11. **nbn** internal Drawing Quality Audit/Conversion tool will produce a KMZ file image located correctly when opened in Google Earth.

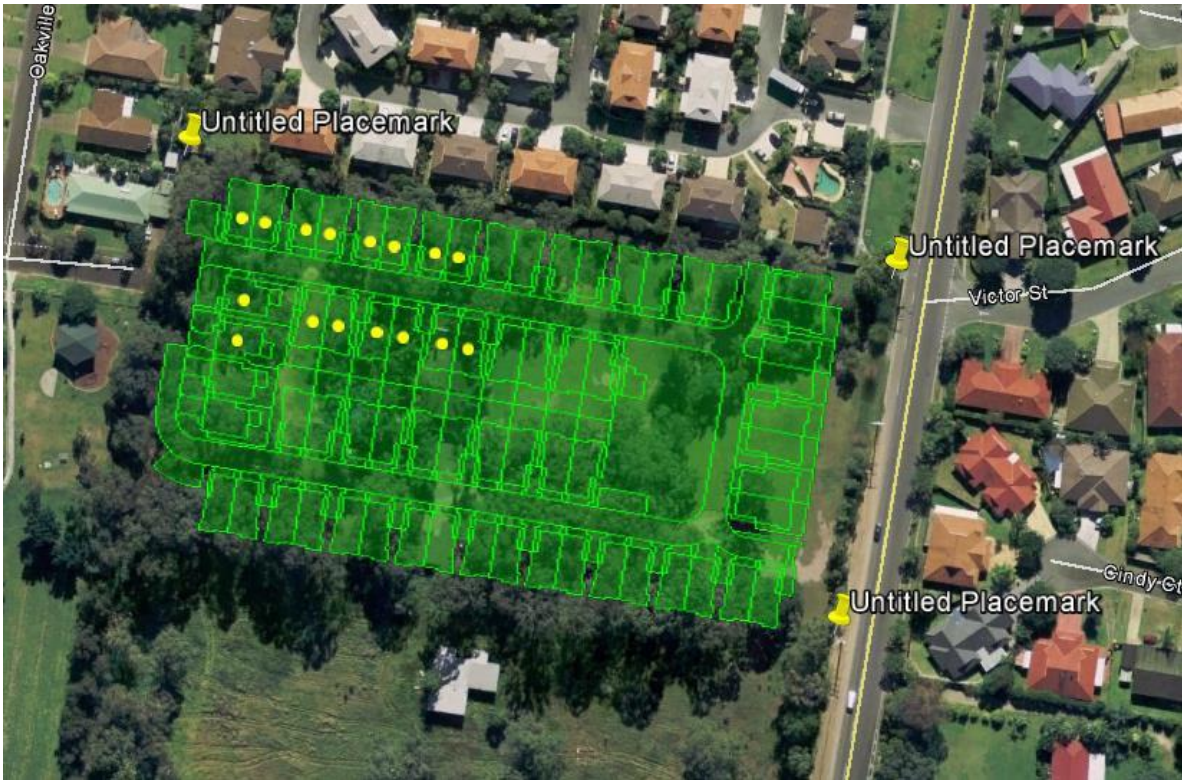

**Note:** Sometimes you have to zoom to Extents to be able to see both your drawing and the reference points. Use the Clipboard to cut and paste the drawing closer to its reference points. Rotation, scaling and final moving to the position will be easier then.

In the example below, the drawing is too far away from the correct location:



### 3.3.2 Using Google Earth only

In most cases it is easy to identify reference points in Google Earth directly. This process involves fewer steps as per the example below:

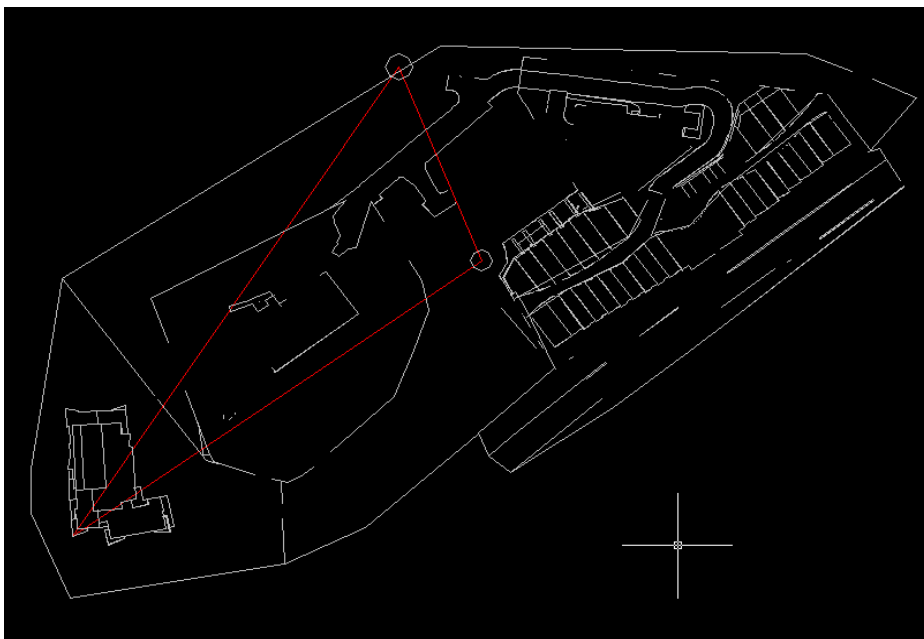

1. From the **3D View** tab in the *Google Earth Options*, select **Universal Transverse Mercator (UTM)**.

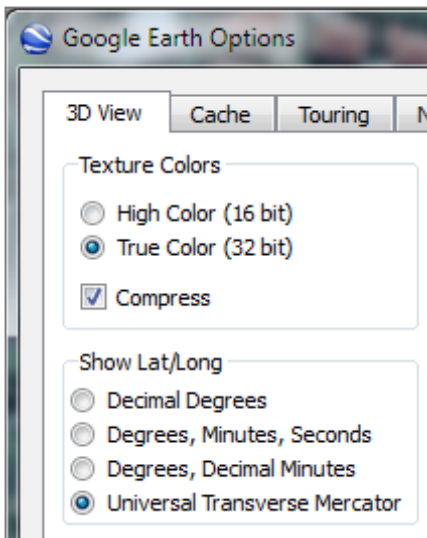

2. Create Google Earth placemarks at the reference points and use those coordinates in your drawing to create reference points.

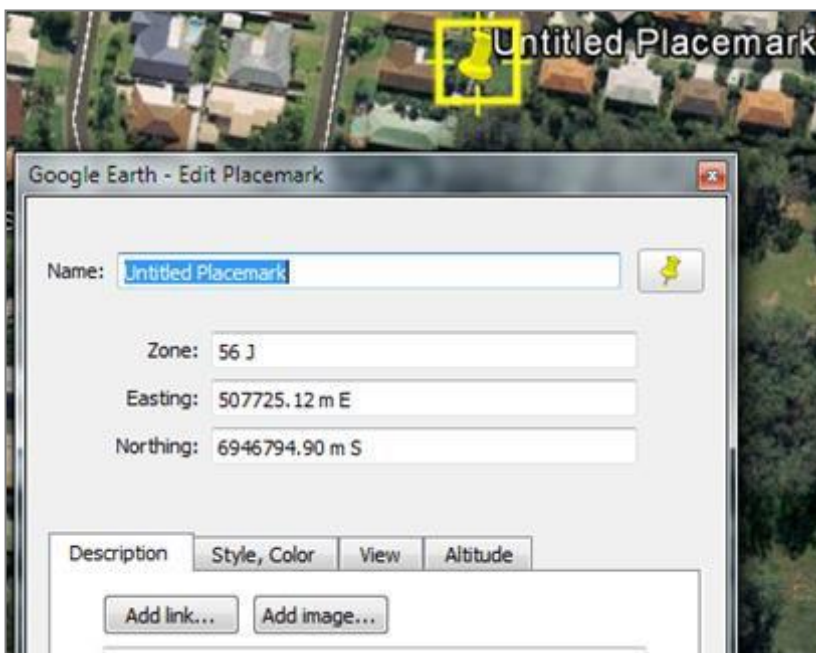

3. Move/scale/rotate the drawing to match the drawing's base points to reference points as already described.

## 3.4 XData (extended entity data)

Xdata is attached to CAD entities as a necessary requirement for the translation of attribute data between the AutoCAD dwg file and the **nbn** Physical Network Inventory database.

This is in addition to the standard object data attributes that are used purely for visual representation.

ADT creates Xdata where necessary during its use. Xdata should not be edited directly. Objects containing Xdata should not be copied or moved around, as Xdata reflects the topology of the network.



## 4 Assisted drafting tool (ADT)

The ADT is provided in the zip file to assist in capturing the **nbn** Pit and Pipe network and in auditing the design for compatibility with the **nbn** CAD requirements and database compatibility before submission.

Please note the following when using the ADT:

1. The tool is designed to automate the process of pit and pipe drafting and its use is **Mandatory**.
2. In order to exit any command you **MUST** press <**Enter**>, NOT <**Esc**> (pressing <**Esc**> breaks the loop and also breaks the program).

The **nbn** approved template has been provided as a starting point for you to complete with details of your design and also to assist you in providing a design that is consistent with **nbn** CAD standards for pit and pipe network elements. The template includes all required Symbols, Blocks, Layers and settings.

### 4.1 Installation instructions

Download the zip file containing the tool from the **nbn** website.

Load the tool into the drawing:

1. Save the **ADT.VLX** file or its updated version to your computer.
2. Open the **nbn** AutoCAD Template.  
**Note:** ADT does not work with other templates.
3. Type **upload** in the command line.

The *Load/Unload Applications* screen will display prompting you to browse for the file you want to load:

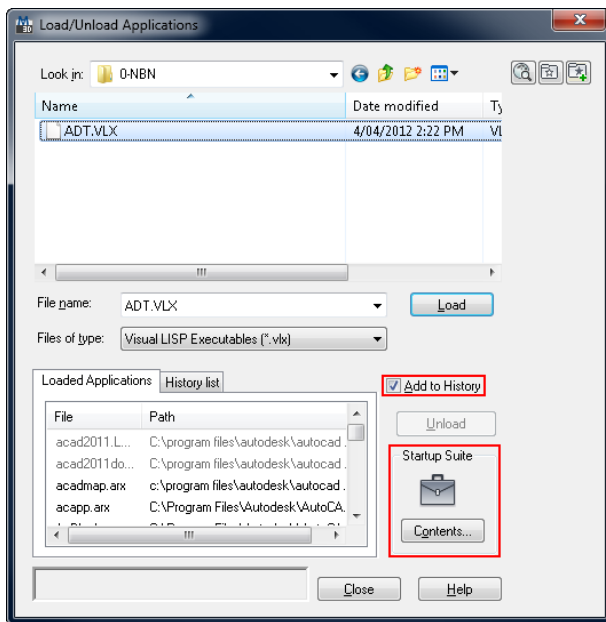

**Note:** if the file is not added to history and start-up suite, it will need to be loaded every time you open up a drawing.

## 5 Drafting guidelines

This section describes the methods of data capture to assist Developers in complying with **nbn** CAD and database compatibility standards.

### 5.1 Cadastre layer fix

Before you begin, ensure the cadastre (or property survey data) is in the **L141 Cadastre** layer.

**Note:** the **PIT** command will not work if the cadastre layer is not set to **L141 Cadastre**.

Please keep the cadastre layer as simple as possible.

The **nbn** internal drawing Quality Audit/Conversion tool creates a polygon out of any line work that looks like a polygon visually, because polygons are expected to be lot boundaries primarily.

Unnecessary cadastre layer imagery will slow the processing of your drawing considerably, causing a queue to form. This will result in a delay in the review of your and other people's drawings.

The Cadastre layer must contain only the line work helpful with pit placement when using ADT PIT command and must also provide sufficient visual reference for easy drawing review by **nbn** planning (i.e. lot boundaries, roads, roundabouts, footpaths, driveways, road reserve and parking bays).

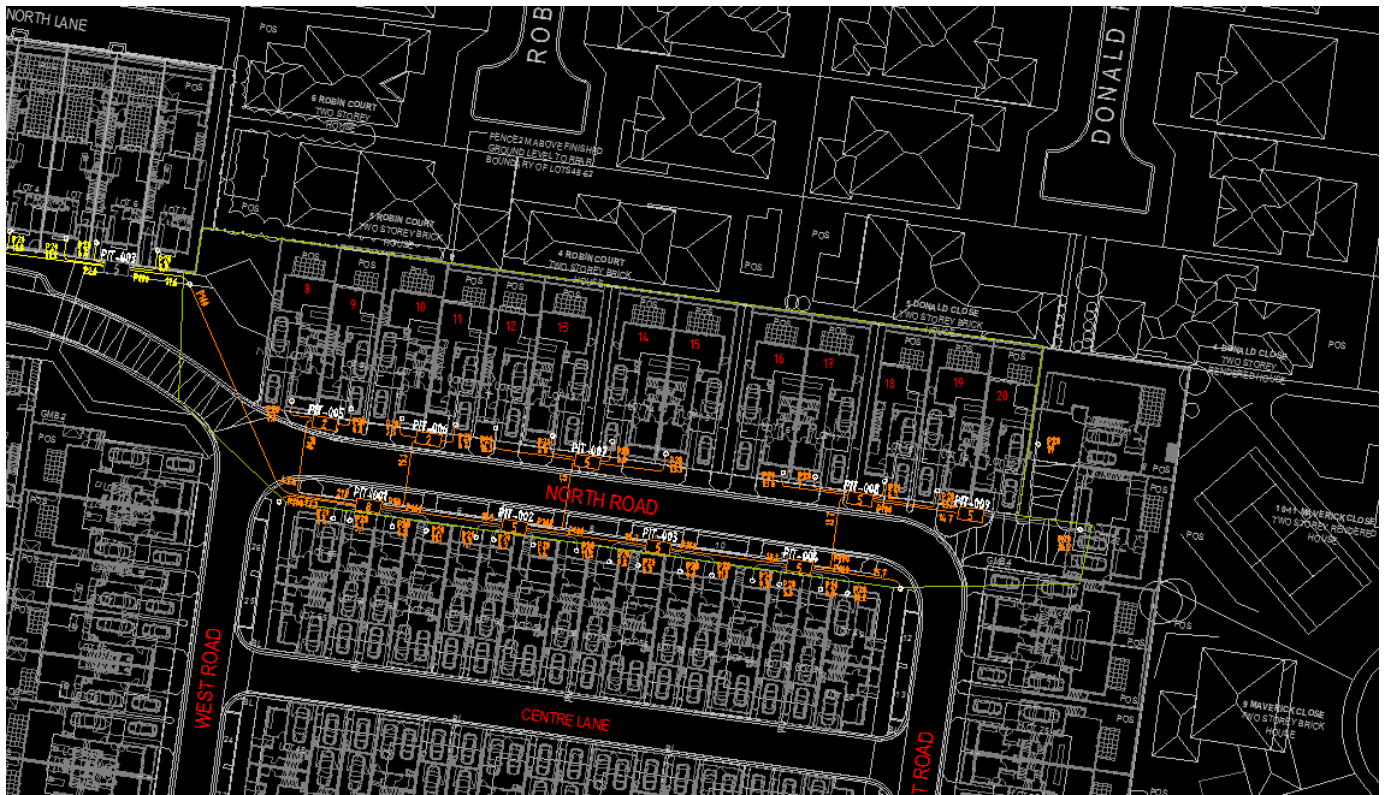

Figure 6. Bad cadastre layer example

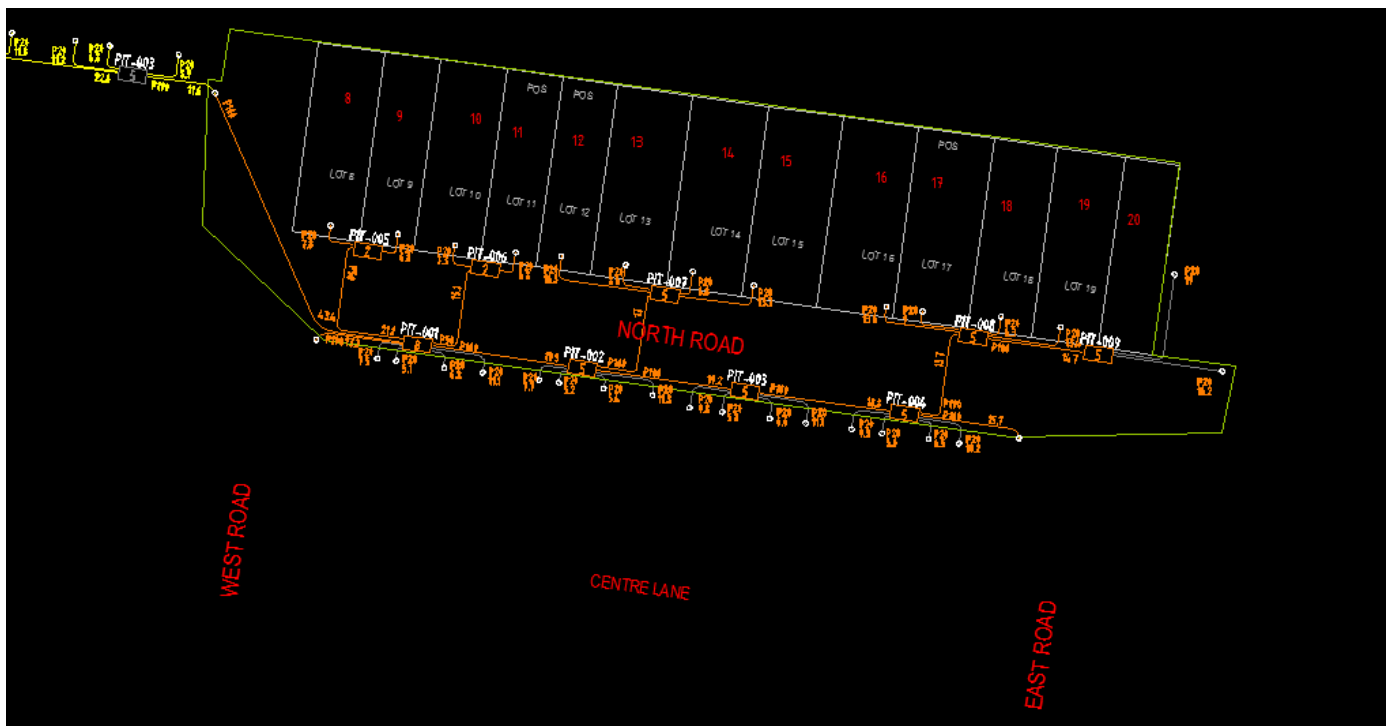

Figure 7. Good cadastre layer example



**Note:** please refer to the tutorial for detailed instructions on copying the property survey data into your drawing.

## 5.2 Different stages displaying standards

In order to show previous stages, future submissions, other carrier networks etc. - it is important to follow a standard colour format regime.

This colour format enables **nbn** to review submissions in less time and with greater accuracy. Please use the table below for colour formatting:

**Table 5. Colour formatting**

Colour	Description
Grey (8)	Future Stages / Future Submissions / Separate Layer
Orange (30)	Current Development Stage / Current Development Submission
Blue (5)	Other Carriers Network (i.e. Telstra, Optus, Etc )
Red (1)	Current Stage As-Built
Yellow (2)	Existing <b>nbn</b> Pit and Pipe Network. Existing pits connected to the current stage must stay in the <b>L462 NBN Support – Pits layer</b> . All other existing network should be moved to a non- <b>nbn</b> layer.

## 5.3 Current development stage boundary

The Current Development Stage Boundary goes around the pit and pipe drafting area. For Horizontal Multi Dwelling Unit (HMDU) the pit and pipe drafting area is inclusive of all street facing premises, pit and pipe connectivity of these premises shall link to the internal pit and pipe of the development. The ADT tool works inside the boundary. The boundary must consist of one closed polyline. It must be in the **L331 NBN Boundaries - GDAs** layer. The boundary colour must be **ByLayer**.

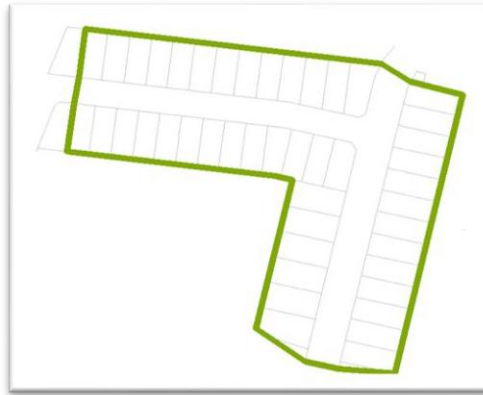

Figure 8. Current development stage boundary

## 5.4 Development information

Development information must be present in the drawing.

**Note:** All fields in development information block (**NBN\_NDI**) should be populated. **NBN\_NDI** block should be in

Table 6. Development attributes

Attribute	Description
DEV_NAME	Development Name
DEV_COMP	Development Company
DEV_ADD	Development Address
DEV_NBNREF	<b>NBN</b> Reference Number for Development
DEV_STG	Development Stage
DEV_REP	Development Authorized Representative
DEV_MOB	Authorized Representative's Phone number
DEV_EML	Authorized Representative's email



SDU Development Information	
Development Name: ds	
Developer Company: dsf	
Development Address: sf	
Authorised Rep: dsf	
Phone: sf	
E-Mail: sdf	
nbn Reference Number: sf	Stage Number: sdf
	Design Revision: adr

Figure 9. Example of development information in the drawing

## 5.5 Addresses

Address/lot information must be captured.

BOM Command (see [Section 5.11 – Bill of Materials](#)) counts the total number of address blocks in the drawing, recording it in the **NO OF LOTS** section.

ADT uses **NBN\_ADDRESS\_SDU** block to present lot numbers in your drawing. Line type and line weight must all be set to **By Layer**.

**Important Note:** In order to display the street name and assist in automating the addressing process, address texts (either Text or MText) should be in the **L140 Addresses** layer. Street name and street type should be one Text/MText object. For example, creating **MARBLE** as one text and **LANE** as another text in the case of **MARBLE LANE** is incorrect.

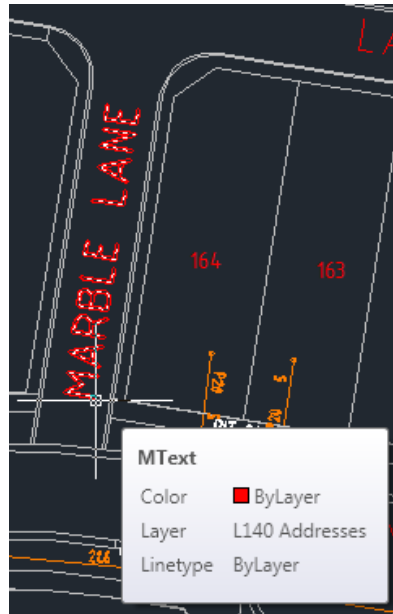

**Figure 10. Example of street name as one MText object**

ADT places the **NBN\_ADDRESS\_SDU** block in the **L140 Addresses** layer. Refer to the table below for **NBN\_ADDRESS\_SDU** block attributes.

**Table 7. Address block attributes**

Attribute	Prompt	Explanation
STREET_NUMBER	Enter the street number for this building.	This is the lot number of the current stage.
ID	Enter the GNAF ID of this address.	This attribute is used for data translations and should be left empty.
STREET_NAME	Enter the street name.	This is the street name for the current stage. It contains both the street name and street type e.g. MARBLE LANE.

**Important Note:**

The combination of the **STREET\_NUMBER** and **STREET\_NAME** attribute values must be unique i.e. each street address text has to be unique. You may use the street number prefix or suffix, such as 1A, if necessary.

The **nbn** Internal Drawing Quality Audit/Conversion tool counts multiple **NBN\_ADDRESS\_SDU** blocks with the same street address as just one lot, while BOM command counts all instances of **NBN\_ADDRESS\_SDU** block within the current stage boundary.

Any discrepancy between the total count of blocks in the BOM and the internal tool's count of blocks,

## 5.5.1 Assisted drafting tool (Address):

After loading the ADT.VLX file into the drawing, perform the following steps to insert an address:

1. Enter **ADD** at command line then follow the prompts
2. The address command counts the existing address inside the development stage boundary

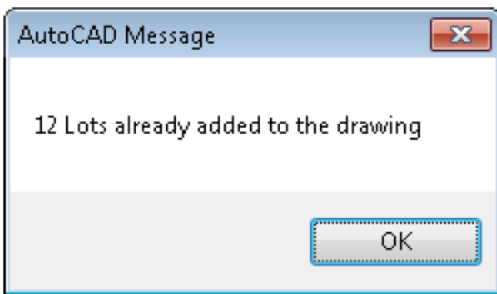

3. Click **OK** and follow these prompts

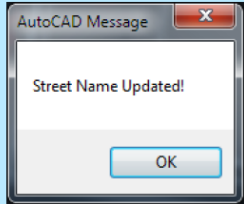
Prompt	Explanation/Action
Please pick an insertion point:	Select the text representing the street name.  <b>Note:</b> This prompt is asking you to pick an insertion point for the address block. Yet, your very first insertion point should always be the street name along which you are going to create addresses. You must select a street name from the <b>L140 Addresses</b> layer. The <b>ADD</b> command does not work with other layers' street name texts.
	
	Above is an example of the message displayed when the street name is first selected or changed.

Please enter Premise      Enter **Yes** for standard Premise. – **Note:** For NPL Premise, enter **SPECIAL**



Please pick an insertion point: Lot number location has to be picked this time

Please enter lot number or  
press Enter for (x):

Enter the lot number with the desired prefix or suffix.

**Note:** You can enter the lot number or press **Enter** or space bar to accept the default value (x) offered.

If you choose to prefix or suffix lot numbers with letters (i.e. **1A**, **A1**) the tool is capable of automatically assigning prefix and suffix letters for you. Please refer to the tutorial for details.

Please note, that neither suffix nor prefix get incremented automatically in alphabetic order when you click next insertion point. For example, instead of the 101A, 101B, 101C you might be expecting, the generated sequence will be 101A, 102A, 103A.

Please pick an insertion point: You are in the loop of creating new addresses. From here on you can left-click at a new insertion point, then press **Enter** or **Space** to keep creating as many addresses as you need - if you are happy with the automatically generated lot number value.

Other actions at this prompt:

- Pick a different street name to start creating addresses along that street.
- Press **Enter** or **Space** to finish the **ADD** command.

Prompt	Explanation/Action
Please enter lot number or press Enter for (xx):	Lot number (xx) offered as a default will be the previous value incremented by one. The simplest response would be to accept it by pressing <b>Enter</b> or <b>Space</b> . Alternatively you can edit the lot number as described above.









## 5.6 Pits & Manholes

ADT uses **NBN\_PIT** block to present pits in your drawing. Line type and line weight must be set to **ByLayer**. ADT puts **NBN\_PIT** block in the **L462 NBN Support – Pits** layer.

Please refer to the table below for allowed pit types.

**Table 8. Pit types**

Type	Symbol	Description
P2		Service Drop Access Pit (650mmX280mmX565mm)
P5		Network Boundary/Local Network Pit (Single Lid) (700mmX450mmX650mm)
P6		Distribution/Local Network Connection Pit (Dual Lid) (1360mmX555mmX650mm)
P8		Distribution/Local Network Connection Pit (Dual Lid) (1360mmX555mmX860mm)
P9		Fibre Distribution Hub (FDH) Pit (2000mmX555mmX900mm)
Manhole		Distribution Network manhole (2600mmX1240mmX1490mm)

Please refer to the table below for the **NBN\_PIT** block attributes description.

**Table 9. NBN\_PIT- block attributes**

Attribute	Prompt	Explanation
NAME	Enter the <b>nbn™</b> (or 3rd Party) Pit Name	This is <b>nbn's</b> identifier for the PIT.
TYPE	Enter the Pit Size	This attribute shows the type of PIT. <b>Note:</b> Pit types allowed are 2, 5, 6, 8 or 9.



**Notes:**

- The **PIT** command will automatically align the pit to the nearest cadastre layer polyline (property border, etc). If the line is vertical, the pit will be aligned vertically, for example. It will also optimise the distance to the line. It will not allow you to create an active pit outside the current development stage boundary. **Please refer to the tutorial for a detailed description of the PIT command behaviour.**
- There is no X-data attached to the pit. Pit Size can be updated by updating the **Pit Type Attribute**.
- Design pits are to be offset from the boundary as to not interfere with any driveways or proposed driveways.
- In document NBN-TE-CTO-194, sections 4.7.3; 4.7.3.1; 4.7.3.3 describe a laneway rear load deployment solution where pits do cross the property boundary.

## 5.6.1 Assisted drafting tool (PIT):

After loading the ADT.VLX file into the drawing, complete the following steps to insert a pit:

Enter **PIT** at command line then follow the prompts:

Prompt	Action/Explanation
Please Pick an Insertion point or press enter to finish.	Left-click where you want the pit to be placed. Your choice of insertion point will be adjusted by the ADT to ensure the pit is parallel to the nearest cadastre layer line and is at an optimal distance from that line.
PLEASE SPECIFY WHETHER THE PIT IS A DEMARCATION PIT OR NOT.	<b>No</b> for Standard pit. <b>Please note:</b> for a NPL pit, enter <b>YES</b> .
Please enter the pit size or press Enter for (5):	Acceptable Pit Sizes are: 2, 5, 6, 8 and 9.

**Notes:**

- The ADT automatically assigns the next sequential pit number to each new pit placed in the **L462 NBN Support – Pits layer**.
- The **PIT** command creates a pit insertion loop. In order to exit the loop press **Enter** - do not press **Esc**.



## 5.6.2 Assisted drafting tool (Manhole):

After loading the ADT.VLX file into the drawing, complete the following steps to insert a manhole:

1. Enter **MHL** at command line then follow the prompts:

Prompt	Action/Explanation
PLEASE PICK AN INSERTION POINT OR PRESS ENTER TO FINISH	Left-click where you want the manhole to be placed. Your choice of insertion point will be adjusted by the ADT to ensure the manhole is parallel to the nearest cadastre layer line and is at an optimal distance from that line.

### Notes:

- The ADT automatically assigns the next sequential manhole number to each new manhole placed in the **L462 NBN Support – Pits layer**.
- The Manhole command creates a manhole insertion loop. In order to exit the loop press Enter - do not press Esc.

## 5.7 Conduits

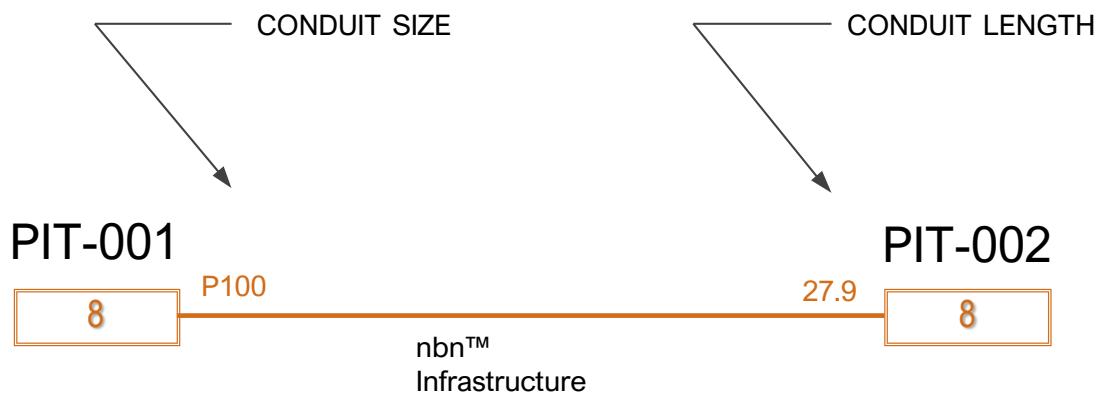

**Figure 11. Conduit**





Conduit is captured in the **L460 NBN Support – Underground** layer with both Line type and Line weight properties set to **ByLayer**.

Conduits in the drawing consist of the following:

**Table 10. Parts of conduit drawing**

Part	Definition
Duct Polyline	A Polyline representing a Duct
NBN_TRENCH_ANNOTYP E	Block representing Duct Type annotation
NBN_TRENCH_ANNOLEN	Block representing Duct Length annotation

XData Attributes for DUCT – for data attribute translation:

**Table 11. XData attributes for DUCT**

Attribute	Definition
TYPE	DUCT (Denotes the Polyline type)
ID	Duct ID (i.e. DCT-001, DCT-002, ... )
SIZE	Duct Size (P100, P50, P20)
LENGTH	Calculated Length

**Note:** Xdata reflects the actual topology of the network and is populated by the DCT command. Ducts should not be moved or copied after being created with the DCT command. Xdata must not be changed directly either.

### 5.7.1 Assisted drafting tool (conduit):

After loading the ADT.VLX file into the drawing, complete the following steps to insert the conduit:

1. Enter **DCT** at the command line.

The program will ask to pick a start point of conduit and continue your conduit line to the next pit.

**Note:** do not press **Esc** as it cancels the command.

2. Press **Enter** when you finish drawing the conduit. The program draws a Polyline representing a duct.
3. **PLEASE ENTER THE CONDUIT TYPE OR PRESS Enter FOR (P100).**

#### 4. PLEASE ENTER CONDUIT LENGTH OR PRESS ENTER FOR (x).

**Notes:**

- You have the option of entering conduit length or using the calculated length.
- The **DCT** command is capable of capturing Road Crossing, Multiple Ducts and Lead-In Conduits.

### 5.7.1.1 Multiple conduits

**Note:** Use the **DCT** command for multiple conduits irrespective of their type.

There are two types of multiple conduits:

- matching multiple conduits
- distinct multiple conduits

#### Matching multiple conduits

Conduit start and end pits are the same and the lengths of the conduits are the same. In this case two lines representing the conduits are stacked on top of each other. See image below:

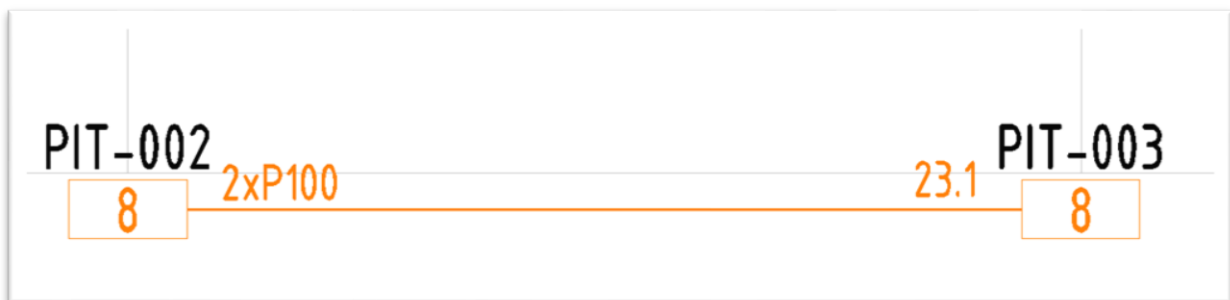

Figure 12. Matching multiple conduits

### 5.7.1.2 Distinct multiple conduits

Conduits are going in the same direction, but their start or end pits are not the same. Separate lines have to be drawn. Express conduits are an example of this installation. **NBN** Planning may advise if express conduits are required within a developments stage/s. See image below:

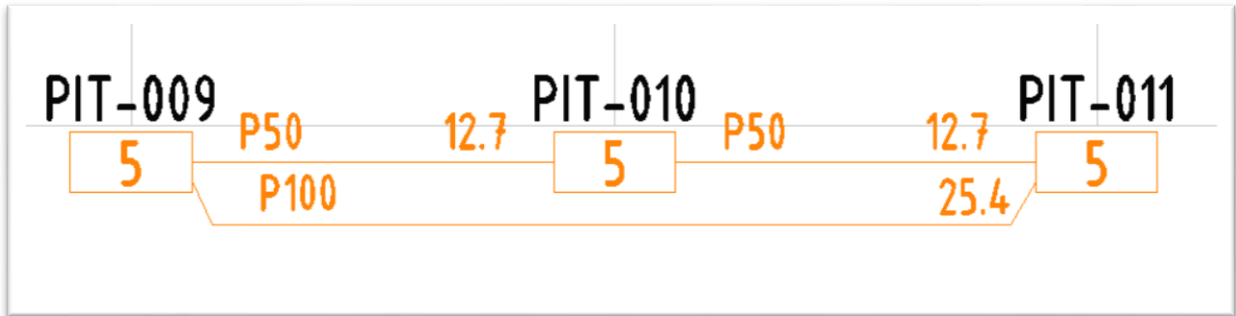

Figure 13. Distinct multiple conduits

### 5.7.1.3 Manhole and conduit configuration

Conduits linking between Manholes from any one end can be either 6 x P100 or 4 x P100 & 2 x P50.



Figure 14. Distinct multiple conduits (manhole)

### 5.7.1.4 Lead-ins

When no **NBN\_PIT** is chosen as the duct end, the **DCT** command will create a Lead-In with **NBN\_CAP** block as its endpoint. The **NBN\_CAP** will be placed in the duct layer **L460 NBN Support – Underground**. Refer to the table below for **NBN\_CAP** attributes.

Table 12. **NBN\_CAP** block attributes

Attribute	M/O	Prompt	Explanation
ID	M	Enter a Unique ID within this drawing for this null node.	This is the <b>nbn</b> identifier for the end cap and has the format <b>NEC-XXX</b> .  <b>XXX</b> is a 3 digit number starting from 001 and incrementing sequentially.

TYPE M Enter the type for this null ENDCAP  
node.

**Note:** The **DCT** command will place **NBN\_CAP** at an end of a conduit (road crossing, or a conduit going beyond the current development stage boundary).

## 5.7.2 Assisted drafting tool (Duct Update Command)

After loading the ADT.VLX file in to the drawing, complete the following steps to edit a conduit without rebuilding it completely.

### Edit a conduit

1. Enter **DCTUPD** at the command line.

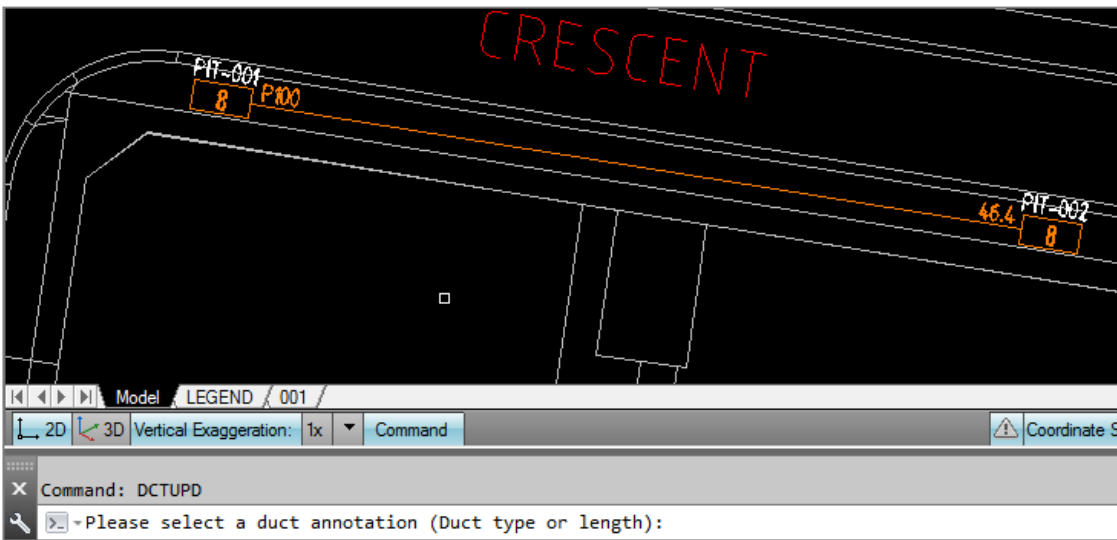

2. Select duct type annotation if you have to edit duct type.
3. The program will ask you to select the line the annotation is related to.

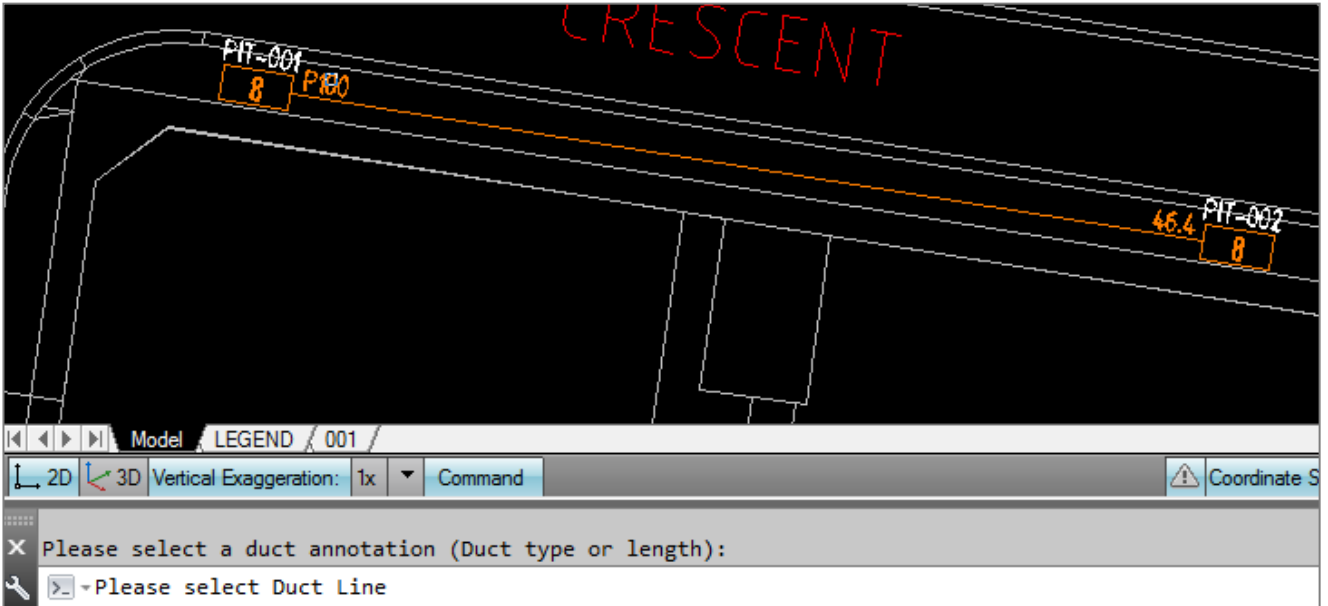

The program will ask you to enter the desired type.

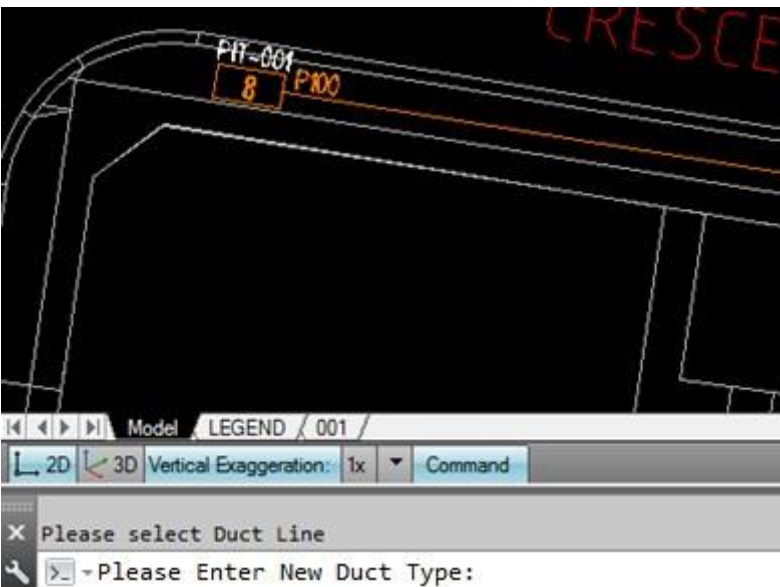

Enter the duct type (P50 in this example).

Note: The conduit type will be updated in both the annotation and the line Xdata.

Similar steps are applicable if you choose to update duct length.

In the example below, the duct length was updated to 47 metres and as you can see, the BOM automatically reflects the changes. It would not have happened if the annotations were edited manually. **DCTUPD** changes the line's Xdata (BOM uses Xdata for its summaries).

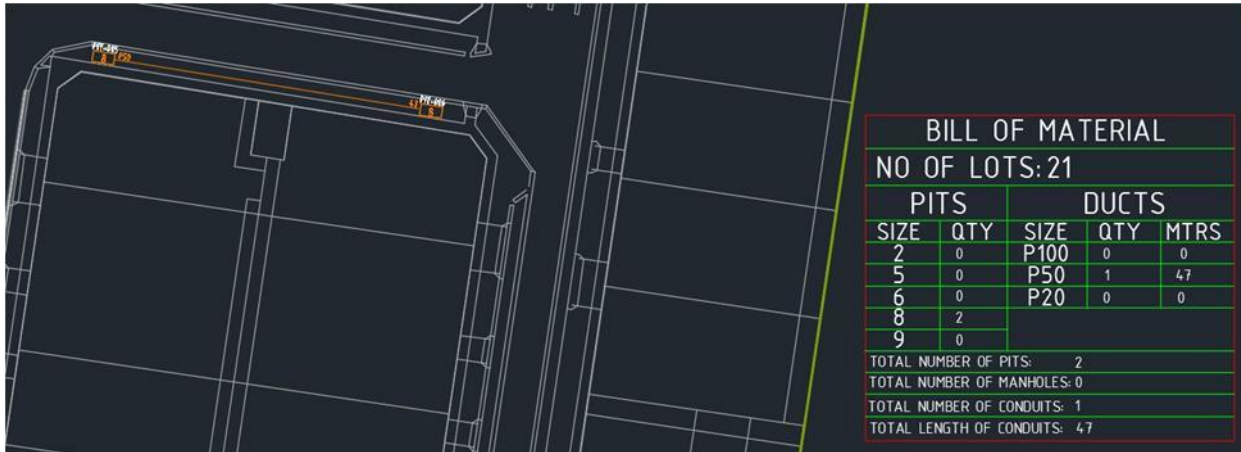

Figure 15. BOM reflects the edits made

## 5.8 EPR Zone (earth potential rise zone)

EPR Zones must be reflected in the design/s. Refer to **nbn** standard **NBN-TE-CTO-194** for **nbn**'s requirement.

### 5.8.1 Assisted drafting tool (EPR)

Use the following steps to insert an EPR Zone.

1. Enter EPR at the command line then follow the prompts:

Prompt	Action/Explanation
PLEASE PICK AN INSERTION POINT OR PRESS ENTER TO FINISH	Left-click where you want the EPR Zone to be placed.

#### Notes:

- The EPR Zone is placed in the **EPR layer**.
- The EPR command creates an EPR insertion loop. In order to exit the loop press Enter - do not press Esc.
- Insert EPR symbol

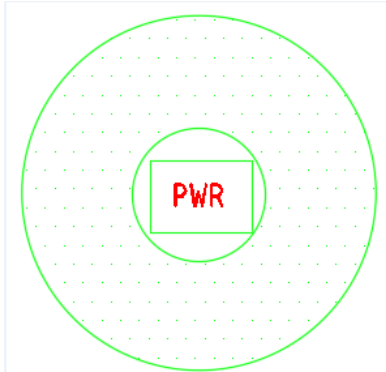

## 5.9 Shared Trench Symbol

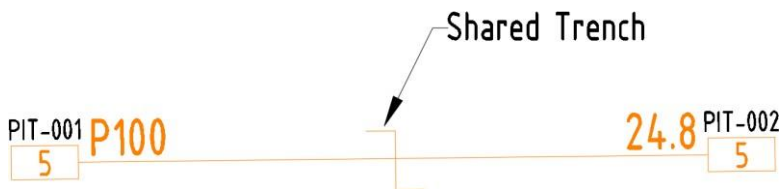

### 5.9.1 Assisted drafting tool (STR)

Use the following steps to insert a Shared Trench Symbol

1. Enter STR at the command line then follow the prompts:

Prompt	Action/Explanation
PLEASE PICK AN INSERTION POINT OR PRESS ENTER TO FINISH	Left-click where you want the Shared Trench symbol to be placed.

#### Notes:

- The Shared Trench symbol is placed in the **Shared Trench layer**.
- The Shared Trench command creates an Shared Trench insertion loop. In order to exit the loop press Enter - do not press Esc.



## 5.10 FDH cabinet

ADT uses the **NBN\_FD**H block to present FDH cabinets in your drawing.

The **NBN\_FD**H block is drafted in the **L552 NBN Sites – FDHs** layer. Line type and Line weight properties are set to **ByLayer**.

See the table below for **NBN\_FD**H block attributes.

**Table 13. NBN\_FD**H block attributes

Attribute	M/O	Prompt	Explanation
NAME	O	Enter the <b>nbn</b> <sup>TM</sup> FDH Name	This is <b>nbn</b> 's identifier for the FDH and has the format <b>FDH-XXX</b> . It is necessary to leave this number as <b>FDH-XXX</b> since the FDH number will be determined by the network planner.
TYPE	M	Enter the number of Local Ports in this FDH	This attribute shows the type of FDH. The FDH type used in Greenfields defaults to 576.

### 5.10.1 Assisted drafting tool (FDH):

After loading the ADT.VLX file into the drawing, follow these steps:

1. Enter **FDH** at command line.
2. At the prompt **PLEASE SPECIFY THE LOCATION ON THE FDH CABINET**: select the place of the cabinet. At the prompt **PLEASE SPECIFY THE ROTATION ANGLE**: move the mouse away from the insertion point to see the line that helps you define the angle, then click to specify the rotation angle.

The FDH block will appear in your drawing.

## 5.11 Telstra PIT

To capture Telstra pits, use the **TPT** command. This will place a **NBN\_TPT** block in the **L402 Telstra Support – Pits**

layer. Line type and Line weight properties are

set to **ByLayer**. See table 15 for **NBN\_TPT**

block attribute description:





**Table 14. NBN\_TPT block attribute**

Attribute	M/O	Prompt	Explanation
SIZE	M	Size	The size of the Telstra Pit

### 5.11.1 Assisted drafting tool (TPT):

3. Enter **TPT** at the command line.
4. At the prompt **PLEASE PICK AN INSERTION POINT OR PRESS Enter TO FINISH**, select the place for the Telstra pit.
5. At this prompt **PLEASE ENTER TELSTRA PIT TYPE, (M) for MANHOLE, Enter FOR (5)**, either press **Enter** to accept **5**, or type a different number or **M** and press **Enter**.
6. To exit the loop of Telstra Pit creation, press **<Enter>** when asked to pick an insertion point again.

## 5.12 Smart Places Non-Premises Locations (NPL)

Smart place products enable connection to locations that are not classified as premises (Non-Premises Locations: NPL). These locations can be:

- Traffic Light Controller Cabinet (TUC)
- Cameras (CCTV)
- Utility Sensors
- Electronic Signs
- Public WIFI

Where a smart place is required within an estate, a P50 link conduit is required to connect to the customer demarcation pit, this demarcation pit shall be a type 2 pit. An additional P20 will be required to link to the NPL. See section 3.7.7. Smart places in TE-**NBN**-CTO-194 for specific design and construction details.

### **To insert a demarcation pit, follow the below instructions:**

Enter **PIT** at command line then follow the prompts:

**Table 15: PIT Command**

Prompt	Action/Explanation
Please Pick an insertion point or press Enter to Finish.	Left-click where you want the pit to be placed. Your choice of insertion point will be adjusted by the ADT to ensure the pit is parallel to the nearest cadastre layer line and is at an optimal distance from that line. NB demarcation pits can be installed inside POS or reserves.
Please enter the pit size, (2), Press Enter:	Acceptable Pit Size for demarcation pit is a type 2 pit, as per <b>nbn-TE-CTO-194</b>
Please Specify whether the pit is a Demarcation pit or not:	<b>Enter Yes</b> for NPL. <b>Note:</b> for a standard pit, enter <b>NO</b> .

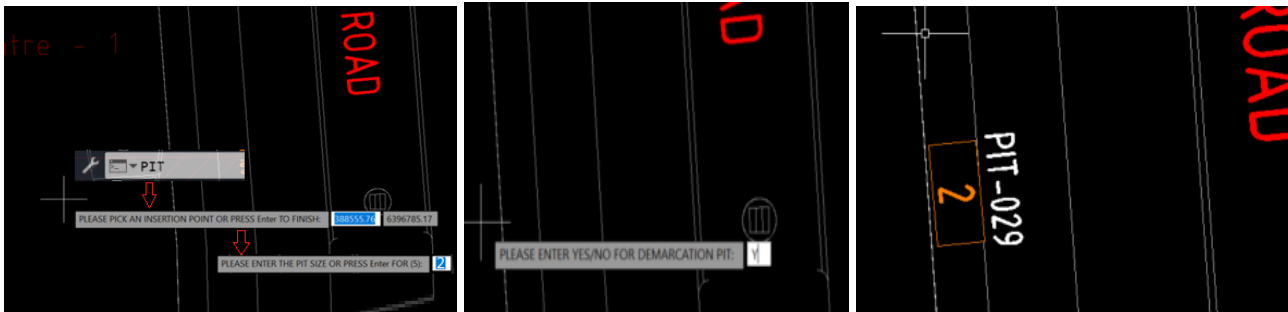

Prompt	Action/Explanation
Check Pit attributes	Double click on pit to check pit attributes to confirm whether the pit is a demarcation pit or not
Please Use DCT command to Join infrastructure.	Use the standard DCT command to make the P50 connection between the standard <b>nbn</b> network to the Demarcation pit, and from the Demarcation pit to the NPL location P20 lead-in Duct.

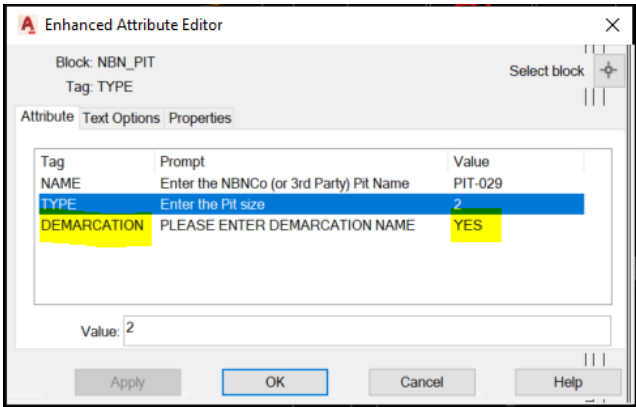

**Table 16: Adding NPL Building Type instructions**

Perform the following steps to insert an address:

1. Enter **ADD** at command line then follow the prompts.
2. The address command counts the existing addresses inside the development stage boundary
3. Click **OK** and follow these prompts:

Prompt	Explanation/Action
Please pick an insertion point:	Select the text representing the street name.  <b>Note:</b> This prompt is asking you to pick an insertion point for the address block. Yet, your very first insertion point should always be the street name closest to the Cabinet or pole. If NPL is on a corner of a road, then select the major highway/road over the minor road which you are going to create addresses. You must select a street name from the <b>L140 Addresses</b> layer. The <b>ADD</b> command does not work with other layers' street name texts.



Above is an example of the message displayed when the street name is first selected or changed.

Please pick an insertion point:	NPL location must be picked this time
Please enter Premise	Enter <b>SPECIAL</b> for NPL. – <b>Note:</b> For standard address enter YES
Press Enter for blank entry or enter lot number if street number is known.	<b>Note: Optional entry</b> and is typically left blank for NPL - press <b>Enter</b> to accept the default <b>Blank</b> value.  If you choose to enter a number, the tool will accept assigned number but can



also be changed in attributed by double clicking on the address/ building name

Please Enter Building Name  
then press Enter

**Enter free text Value, for example:**

- Traffic Light Controller Cabinet (TUC)
- Cameras (CCTV)
- Utility Sensors
- Electronic Signs
- Public WIFI

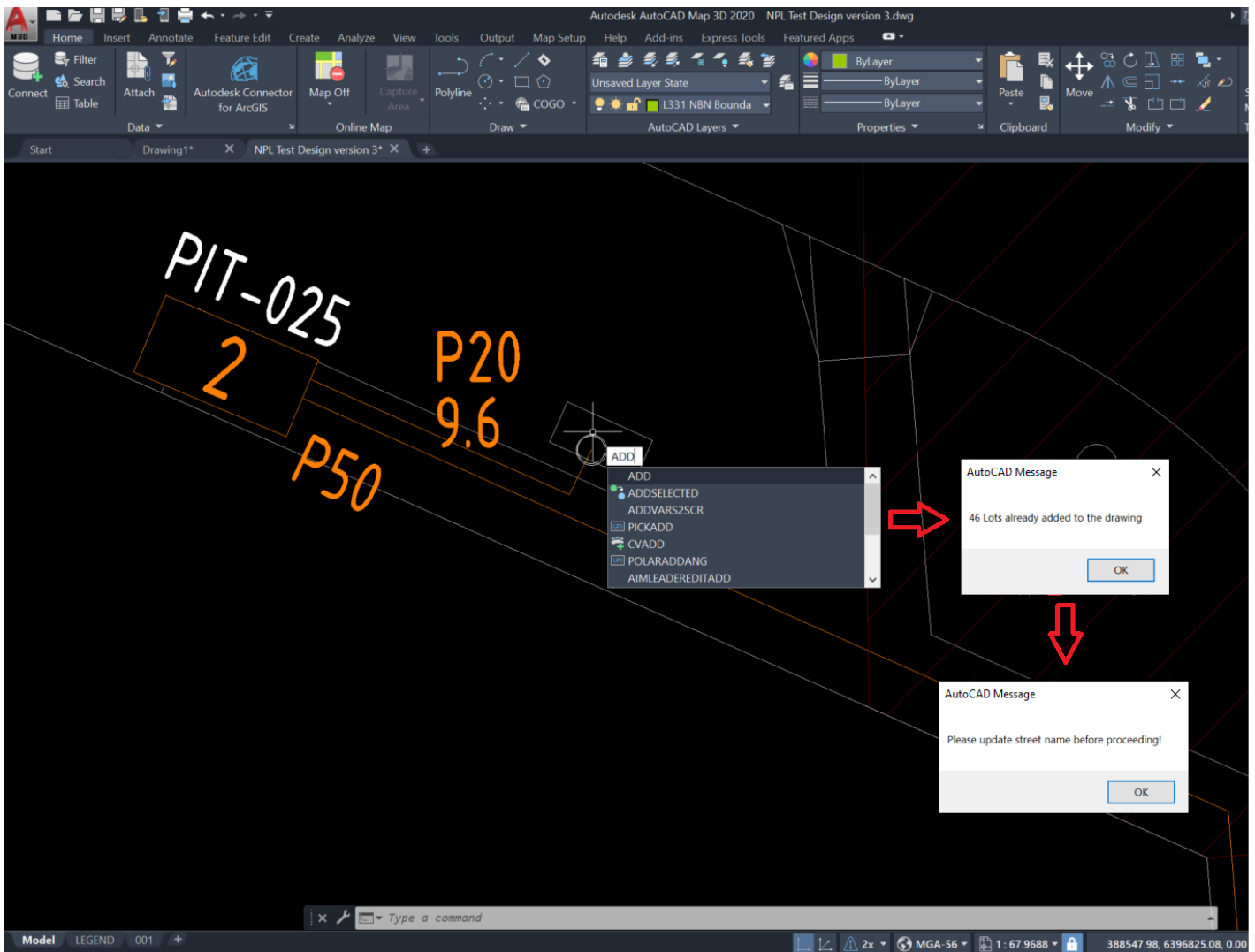

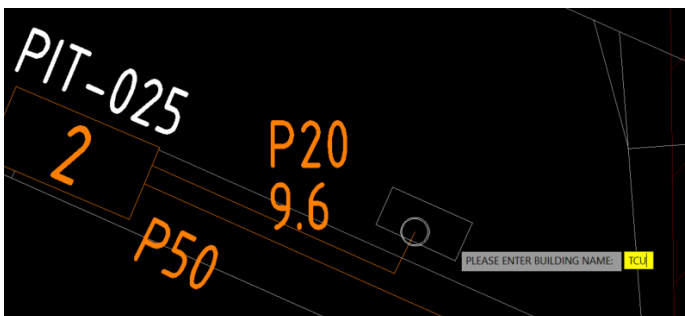
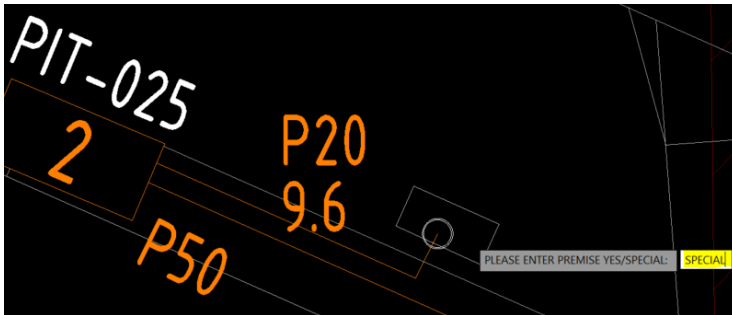

Double click on Building type to check attributes

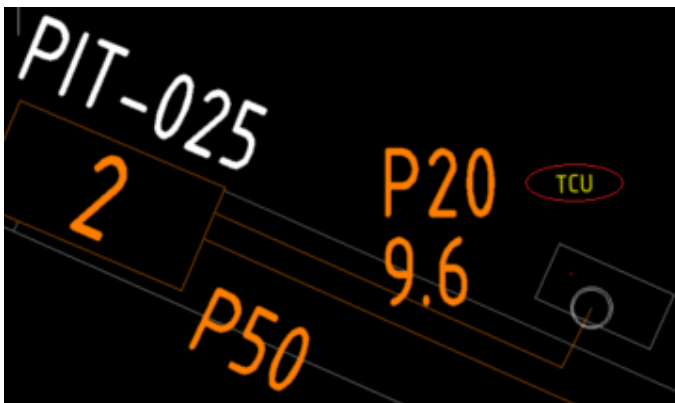

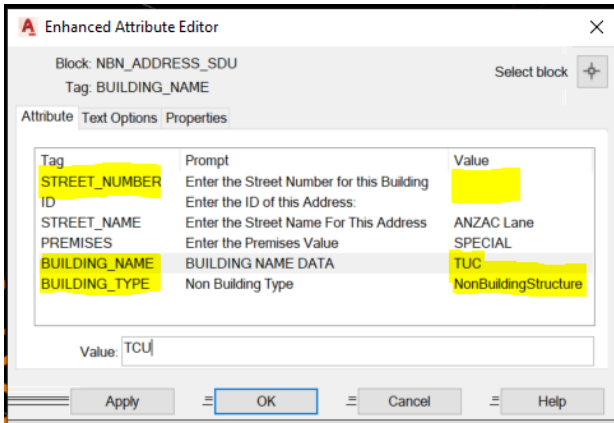

**Table 17: For a Standard Premise**

Please enter Premise	Enter <b>Yes</b> for Standard address– <b>Note:</b> For NPL address enter SPECIAL
Please enter lot number and press Enter (X)	<b>Note:</b> You can enter the lot number and press <b>Enter</b> to accept value (x) as per standard commands under section 5.5.1
To amend Street number double click on Building type or street number	Note, that street number can be amended/ inserted by double clicking on Building type annotation to bring up attributes. Enter details in street number

## 5.13 Bill of Materials

It is important to include a BOM (Bill of Materials) in your drawing.

The ATD will place the BOM on model view using the **NBN\_BOM** in **0-GENERAL-NOTES** layer. Refer to the table below for **NBN\_BOM** block attributes.

**Table 18: BOM block attributes**

Attribute	Explanation
PIT2	Total number of Pit 2
PIT5	Total number of Pit 5
PIT6	Total number of Pit 6



PIT8	Total number of Pit 8
PIT9	Total number of Pit 9
P100	Total number of P100 Conduits
Attribute	Explanation
LP100	Total length of P100 Conduits
P50	Total number of P50 Conduits
LP50	Total length of P50 Conduits
P20	Total number of P20 Conduits
LP20	Total length of P20 Conduits
PIT	Total number of pits (all sizes)
MHL	Total number of Manholes
CONDUIT	Total number of conduits (all sizes)
LENGTH	Total length of conduits (all sizes)
LOTS	Total number of lots



BILL OF MATERIAL				
NO OF LOTS:87				
PITS		DUCTS		
SIZE	QTY	SIZE	QTY	MTRS
2	13	P100	38	1322
5	16	P50	15	311.4
6	3	P20	87	1148.8
8	6			
9	0			
TOTAL NUMBER OF PITS:		38		
TOTAL NUMBER OF MANHOLES:		1		
TOTAL NUMBER OF CONDUITS:		140		
TOTAL LENGTH OF CONDUITS:		2782.2		

Figure 16. Example of BOM in the drawing

**Notes:**

- A Bill of Materials (BOM) must only be created after a successful run of the QA command.
- The BOM summary is done for pits, ducts and lots inside the current development stage boundary only.
- You must insert the BOM on the model view.
- You can scale the block up or down if necessary.

### 5.13.1 Assisted Drafting Tool (BOM):

In order to capture the BOM, please follow these steps:

1. Enter **BOM** at command line.
2. At the prompt **PLEASE PICK AN INSERTION POINT FOR BOM**, pick a point. The snap point is at the top left corner of the block.





## 5.14 Quality audit for pit and pipe design

The QA command helps developers to audit their designs before submitting them to **nbn**. Refer to the table below for the QA tests:

**Table 19. QA command**

Item	Description
Development Information	Checks if: <ul style="list-style-type: none"> <li>Development Information block is inserted</li> <li>All fields are populated</li> </ul>
Boundary Check	Checks if: <ul style="list-style-type: none"> <li>One (and only one) current development stage boundary, drawn with AutoCAD polyline, is present in <b>L331 NBN Boundaries – GDAs</b> layer.</li> <li>There are no AutoCAD lines in the <b>L331 NBN Boundaries – GDAs</b> layer.</li> </ul>
Special cases (QA run against an unfinished design by mistake)	Checks if: <ul style="list-style-type: none"> <li>The only ducts present in the drawing are road crossings.</li> <li>There are no ducts inside the development stage boundary.</li> <li>There are any pits not connected to any duct.</li> </ul>
Pit Check	Checks if: <ul style="list-style-type: none"> <li>All <b>nbn™</b> pits &amp; manholes are set to the right layer and right colour.</li> <li>All <b>nbn™</b> pits are the right type (2, 5, 6, 8 or 9).</li> <li>No active pits are outside the development boundary.</li> </ul> <p><b>Note:</b> previous stage pits connected to the current stage must be coloured Yellow</p>

Item	Description
	<p>(2) —the new tool drags pits back into L462 automatically.</p> <p>Performs the following correction:</p> <ul style="list-style-type: none"> <li>Renumbers pits sequentially starting from one.</li> </ul>
Duct Check	Checks if: <ul style="list-style-type: none"> <li>All ducts have Xdata attached.</li> <li>All ducts have correctly snapped start and end points (to pits/endcaps).</li> </ul>



## 5.14.1 Assisted drafting tool (QA):

Enter **QA** at command line.

The QA command will run and you must fix faulty items if any are found.

If the QA command finds faulty items that need manual correction, it inserts an **NBN\_FIX** block with commentary text.

**Note:** the QA command works in steps. Upon the completion of one step it moves to the next step, so it is extremely important to follow through with the QA command and fix all issues.

Refer to the table below for an explanation of NBN\_FIX errors.

**Table 20. NBN\_FIX text description**

Error Text	Explanation	Required Action
<b>Errors tagged with NBN_FIX block (yellow circle with a short error message)</b>		
TYPE	Pit type is not 2, 5, 6, 8 or 9 or MHL.	Manual editing of the pit type attribute of <b>NBN_PIT</b> block is allowed. Correct the type manually.
NO XDATA	Duct Polyline with no Xdata attached. This error usually means that a problem with one of the ducts was found, like a polyline not created with the DCT command.	Delete the Duct and re-build it with the DCT command.
NO CONNECTION	Orphan pit, or a pit not properly snapped to the duct end, or a duct without a pit/end cap at its start or end.	Make sure there are no orphan pits or unattached duct ends.
SHORT DUCT	Duct polyline length is 2.5 m or less.	You are allowed to draw ducts longer than you need, but the desired length can be entered at DCT command prompt. That value will be shown in the annotation and used in the BOM summaries.

After identifying the issue, please take corrective actions to fix faulty items. If the Quality Audit is successful, the following message will display:

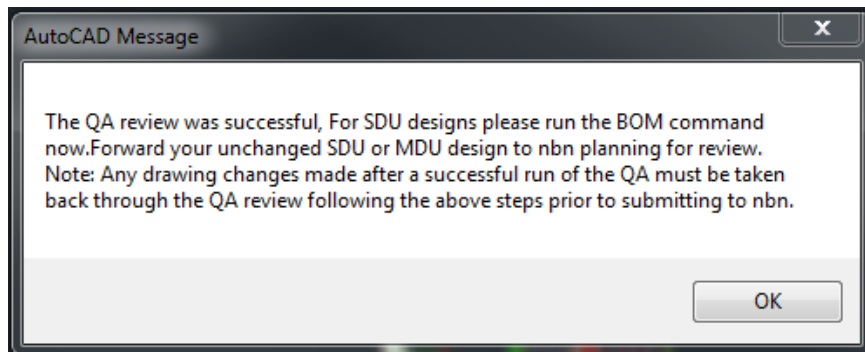

#### Notes:

- This message also advises you to never make changes (apart from running the BOM command) between the last successful run of the QA command and actual emailing of your drawing to **nbn** for review.
- As-Built designs must be converted to Red after the BOM command has been run and then submitted to **nbn** for review.
- Developers should not simply rely on the ADT and must independently ensure that their design complies with all of the requirements of the *New Developments: Deployment of the NBN CO Conduit and Pit Network* –

## 6 Contact us

### 6.1 Design submission and queries

All pit and pipe design submissions are done via the New Developments developer Portal.

All design review and corrective actions queries should be actioned through the **nbn** New Developments Portal.

### 6.2 Assisted drafting tool (ADT) support

For support with ADT or uploading your designs please contact your Deployment Specialist or **nbn** contact in the first instance.

Any additional ADT enquiries relating to technical support or issues email:

[NBNADTQuestions@nbnco.com.au](mailto:NBNADTQuestions@nbnco.com.au).

Hours 9:30am – 4:30pm AEST Monday to Friday.



## 7 Checklists

The process for **nbn** commenting on stage Pit and Pipe designs and updating **nbn**'s systems and database requires Developers to use planning tools and methodologies consistent with **nbn**'s requirements.

Two checklists have been created to assist you:

1. *Pre-Construct Handover Checklist* for New Development P&P Design
2. *As-Built Handover Checklist* for New Development P&P Design

These checklists are designed to ensure that these system and database compatibility requirements have been met.

The *Pre-Construct Handover Checklist* must be submitted in softcopy as part of the AutoCAD design for a stage submitted for **nbn**'s comment, as evidence of having completed all the required checks and data collection activities.

The *As-Built Handover Checklist* should be provided with your notice of practical completion and As-Built. It is important that developers provide an As-Built which readily interfaces with **nbn**'s systems and databases. Developers should work through the As-Built checklist before they submit their notice of practical completion and As-Built drawing. The checklist should be supplied with the As-Built design or it may be requested by **nbn**.

Both checklists are available from the **nbn**<sup>TM</sup> website in the Pit and Pipe

Designs zip file: [Upload designs | nbn \(nbnco.com.au\)](https://nbnco.com.au)

